

# MC 100-500 Pluggable terminal block



Pitch: 5.00mm(0.197inch)



## SPECIFICATIONS

|             |                       |                     | CUL                         | VDE                  |
|-------------|-----------------------|---------------------|-----------------------------|----------------------|
| 負載電壓        | Rated Voltage         | Bemessungsspannung  | AC 300V                     | AC 380V              |
| 負載電流        | Rated Current         | Bemessungsstrom     | 16A                         | 16A                  |
| 電線線徑        | Wire Size             | Leitergrößen        | 24~12AWG                    | 0.2~4mm <sup>2</sup> |
| 塑膠本體        | Housing Material      | Isolierstofftyp     | Polyamide66(UL94V-0)        |                      |
| 押線圈         | Cage Clamp            | Klemmkörper         | Brass, Ni plated            |                      |
| 導電夾片        | Contact               | Kontakt             | Phosphor bronze, Tin plated |                      |
| 螺絲          | Screw Size            | Schraubengewinde    | M3.0, steel, Zinc plated    |                      |
| 操作溫度        | Operating Temperature | Umgebungstemperatur | -40°C to + 105°C            |                      |
| 扭力          | Torque                | Anzugsmoment        | 7.0 lb-inch                 |                      |
| UL File No. | E167040               |                     |                             |                      |

TABLE

| Item No.    | A(mm) | A(inch) |
|-------------|-------|---------|
| MC100-50002 | 10.0  | 0.394   |
| MC100-50003 | 15.0  | 0.591   |
| MC100-50004 | 20.0  | 0.787   |
| MC100-50005 | 25.0  | 0.984   |
| MC100-50006 | 30.0  | 1.181   |
| MC100-50007 | 35.0  | 1.378   |
| MC100-50008 | 40.0  | 1.575   |
| MC100-50009 | 45.0  | 1.772   |
| MC100-50010 | 50.0  | 1.969   |
| MC100-50011 | 55.0  | 2.165   |
| MC100-50012 | 60.0  | 2.362   |
| MC100-50013 | 65.0  | 2.559   |
| MC100-50014 | 70.0  | 2.756   |
| MC100-50015 | 75.0  | 2.953   |
| MC100-50016 | 80.0  | 3.150   |
| MC100-50017 | 85.0  | 3.346   |
| MC100-50018 | 90.0  | 3.543   |
| MC100-50019 | 95.0  | 3.740   |
| MC100-50020 | 100.0 | 3.937   |
| MC100-50021 | 105.0 | 4.134   |
| MC100-50022 | 110.0 | 4.331   |
| MC100-50023 | 115.0 | 4.528   |
| MC100-50024 | 120.0 | 4.724   |

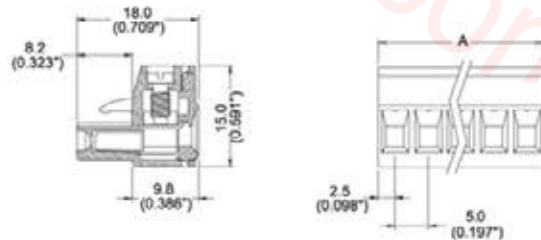

Note:  
Screw Plating: Changes are available upon request  
Cage Clamp: MC 100 # : Steel

# MC 100-508 Pluggable terminal block



Pitch: 5.08mm(0.200inch)



## SPECIFICATIONS

|             |                       |                     | CUL                         | VDE                  |
|-------------|-----------------------|---------------------|-----------------------------|----------------------|
| 負載電壓        | Rated Voltage         | Bemessungsspannung  | AC 300V                     | AC 380V              |
| 負載電流        | Rated Current         | Bemessungsstrom     | 16A                         | 16A                  |
| 電線線徑        | Wire Size             | Leitergrößen        | 24~12AWG                    | 0.2~4mm <sup>2</sup> |
| 塑膠本體        | Housing Material      | Isolierstofftyp     | Polyamide66(UL94V-0)        |                      |
| 押線圈         | Cage Clamp            | Klemmkörper         | Brass, Ni plated            |                      |
| 導電夾片        | Contact               | Kontakt             | Phosphor bronze, Tin plated |                      |
| 螺絲          | Screw Size            | Schraubengewinde    | M3.0, steel, Zinc plated    |                      |
| 操作溫度        | Operating Temperature | Umgebungstemperatur | -40°C to + 105°C            |                      |
| 扭力          | Torque                | Anzugsmoment        | 7.0 lb-inch                 |                      |
| UL File No. | E167040               |                     |                             |                      |

## TABLE

| Item No.    | A(mm) | A(inch) |
|-------------|-------|---------|
| MC100-50802 | 10.2  | 0.400   |
| MC100-50803 | 15.2  | 0.600   |
| MC100-50804 | 20.3  | 0.800   |
| MC100-50805 | 25.4  | 1.000   |
| MC100-50806 | 30.5  | 1.200   |
| MC100-50807 | 35.6  | 1.400   |
| MC100-50808 | 40.6  | 1.600   |
| MC100-50809 | 45.7  | 1.800   |
| MC100-50810 | 50.8  | 2.000   |
| MC100-50811 | 55.9  | 2.200   |
| MC100-50812 | 61.0  | 2.400   |
| MC100-50813 | 66.0  | 2.600   |
| MC100-50814 | 71.1  | 2.800   |
| MC100-50815 | 76.2  | 3.000   |
| MC100-50816 | 81.3  | 3.200   |
| MC100-50817 | 86.4  | 3.400   |
| MC100-50818 | 91.4  | 3.600   |
| MC100-50819 | 96.5  | 3.800   |
| MC100-50820 | 101.6 | 4.000   |
| MC100-50821 | 106.7 | 4.200   |
| MC100-50822 | 111.8 | 4.400   |
| MC100-50823 | 116.8 | 4.600   |
| MC100-50824 | 121.9 | 4.800   |

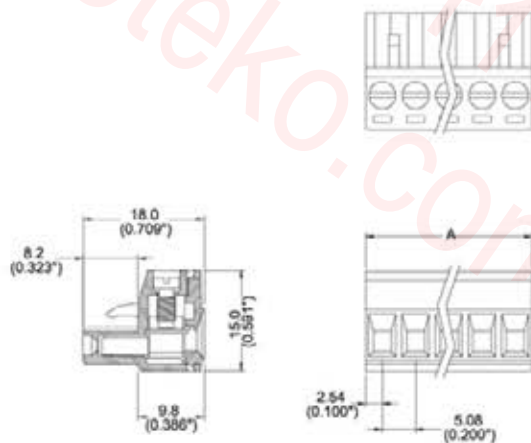

Note:  
Screw Plating: Changes are available upon request  
Cage Clamp: MC 100 # : Steel

# MC 100-762 Pluggable terminal block



Pitch: 7.62mm(0.300inch)



## SPECIFICATIONS

|             |                       |                     | CUL                         | VDE                    |
|-------------|-----------------------|---------------------|-----------------------------|------------------------|
| 負載電壓        | Rated Voltage         | Bemessungsspannung  | AC 300V                     | AC 400V                |
| 負載電流        | Rated Current         | Bemessungsstrom     | 15A                         | 16A                    |
| 電線線徑        | Wire Size             | Leitergrößen        | 24~14AWG                    | 0.2~2.5mm <sup>2</sup> |
| 塑膠本體        | Housing Material      | Isolierstofftyp     | Polyamide66(UL94V-0)        |                        |
| 押線圈         | Cage Clamp            | Klemmkörper         | Brass, Ni plated            |                        |
| 導電夾片        | Contact               | Kontakt             | Phosphor bronze, Tin plated |                        |
| 螺絲          | Screw Size            | Schraubengewinde    | M3.0, steel, Zinc plated    |                        |
| 操作溫度        | Operating Temperature | Umgebungstemperatur | -40°C to + 105°C            |                        |
| 扭力          | Torque                | Anzugsmoment        | 4.5 lb-inch                 |                        |
| UL File No. | E167040               |                     |                             |                        |

TABLE

| Item No.    | A(mm) | A(inch) |
|-------------|-------|---------|
| MC100-76202 | 13.2  | 0.520   |
| MC100-76203 | 20.8  | 0.820   |
| MC100-76204 | 28.5  | 1.120   |
| MC100-76205 | 36.1  | 1.420   |
| MC100-76206 | 43.7  | 1.720   |
| MC100-76207 | 51.3  | 2.020   |
| MC100-76208 | 58.9  | 2.320   |
| MC100-76209 | 66.6  | 2.620   |
| MC100-76210 | 74.2  | 2.920   |
| MC100-76211 | 81.8  | 3.220   |
| MC100-76212 | 89.4  | 3.520   |
| MC100-76213 | 97.0  | 3.820   |
| MC100-76214 | 104.7 | 4.120   |
| MC100-76215 | 112.3 | 4.420   |
| MC100-76216 | 119.9 | 4.720   |

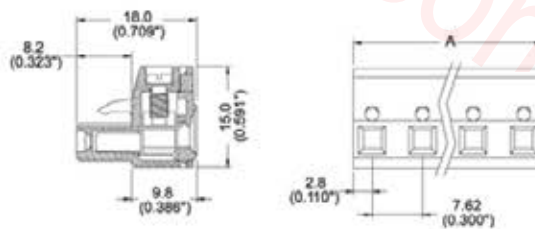

Note:  
Screw Plating: Changes are available upon request  
Cage Clamp: MC 100 # : Steel

Pitch: 5.00mm(0.197inch)

- **Description:**
- Pitch : 5.00mm (0.197inch)

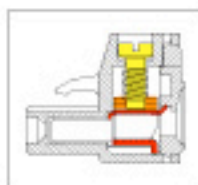

## SPECIFICATIONS

|             |                       |                     | CUL                         | VDE                  |
|-------------|-----------------------|---------------------|-----------------------------|----------------------|
| 負載電壓        | Rated Voltage         | Bemessungsspannung  | AC 300V                     | AC 400V              |
| 負載電流        | Rated Current         | Bemessungsstrom     | 16A                         | 16A                  |
| 電線線徑        | Wire Size             | Leitergrößen        | 24~12AWG                    | 0.2~4mm <sup>2</sup> |
| 塑膠本體        | Housing Material      | Isolierstofftyp     | Polyamide66(UL94V-0)        |                      |
| 押線圈         | Cage Clamp            | Klemmkörper         | Steel, Ni plated            |                      |
| 導電夾片        | Contact               | Kontakt             | Phosphor bronze, Tin plated |                      |
| 螺絲          | Screw Size            | Schraubengewinde    | M2.6, steel, Zinc plated    |                      |
| 操作溫度        | Operating Temperature | Umgebungstemperatur | -40°C to + 105°C            |                      |
| 扭力          | Torque                | Anzugsmoment        | 7.0 lb-inch                 |                      |
| UL File No. | E167040               |                     |                             |                      |

TABLE

| Item No.    | A(mm) | A(inch) |
|-------------|-------|---------|
| MC100#50002 | 10.0  | 0.394   |
| MC100#50003 | 15.0  | 0.591   |
| MC100#50004 | 20.0  | 0.787   |
| MC100#50005 | 25.0  | 0.984   |
| MC100#50006 | 30.0  | 1.181   |
| MC100#50007 | 35.0  | 1.378   |
| MC100#50008 | 40.0  | 1.575   |
| MC100#50009 | 45.0  | 1.772   |
| MC100#50010 | 50.0  | 1.969   |
| MC100#50011 | 55.0  | 2.165   |
| MC100#50012 | 60.0  | 2.362   |
| MC100#50013 | 65.0  | 2.559   |
| MC100#50014 | 70.0  | 2.756   |
| MC100#50015 | 75.0  | 2.953   |
| MC100#50016 | 80.0  | 3.150   |
| MC100#50017 | 85.0  | 3.346   |
| MC100#50018 | 90.0  | 3.543   |
| MC100#50019 | 95.0  | 3.740   |
| MC100#50020 | 100.0 | 3.937   |
| MC100#50021 | 105.0 | 4.134   |
| MC100#50022 | 110.0 | 4.331   |
| MC100#50023 | 115.0 | 4.528   |
| MC100#50024 | 120.0 | 4.724   |

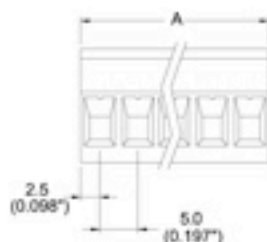
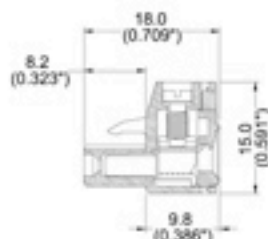

Note:

Screw Plating: Changes are available upon request

Cage Clamp: MC 100- : Brass

Pitch: 5.08mm(0.200inch)

- **Description:**
- Pitch : 5.08mm (0.200inch)

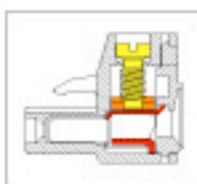

## SPECIFICATIONS

|             |                       |                     | CUL                         | VDE                  |
|-------------|-----------------------|---------------------|-----------------------------|----------------------|
| 負載電壓        | Rated Voltage         | Bemessungsspannung  | AC 300V                     | AC 400V              |
| 負載電流        | Rated Current         | Bemessungsstrom     | 16A                         | 16A                  |
| 電線線徑        | Wire Size             | Leitergrößen        | 24~12AWG                    | 0.2~4mm <sup>2</sup> |
| 塑膠本體        | Housing Material      | Isolierstofftyp     | Polyamide66(UL94V-0)        |                      |
| 押線圈         | Cage Clamp            | Klemmkörper         | Steel, Ni plated            |                      |
| 導電夾片        | Contact               | Kontakt             | Phosphor bronze, Tin plated |                      |
| 螺絲          | Screw Size            | Schraubengewinde    | M2.6, steel, Zinc plated    |                      |
| 操作溫度        | Operating Temperature | Umgebungstemperatur | -40°C to + 105°C            |                      |
| 扭力          | Torque                | Anzugsmoment        | 7.0 lb-inch                 |                      |
| UL File No. | E167040               |                     |                             |                      |

TABLE

| Item No.    | A(mm) | A(inch) |
|-------------|-------|---------|
| MC100#50802 | 10.2  | 0.400   |
| MC100#50803 | 15.2  | 0.600   |
| MC100#50804 | 20.3  | 0.800   |
| MC100#50805 | 25.4  | 1.000   |
| MC100#50806 | 30.5  | 1.200   |
| MC100#50807 | 35.6  | 1.400   |
| MC100#50808 | 40.6  | 1.600   |
| MC100#50809 | 45.7  | 1.800   |
| MC100#50810 | 50.8  | 2.000   |
| MC100#50811 | 55.9  | 2.200   |
| MC100#50812 | 61.0  | 2.400   |
| MC100#50813 | 66.0  | 2.600   |
| MC100#50814 | 71.1  | 2.800   |
| MC100#50815 | 76.2  | 3.000   |
| MC100#50816 | 81.3  | 3.200   |
| MC100#50817 | 86.4  | 3.400   |
| MC100#50818 | 91.4  | 3.600   |
| MC100#50819 | 96.5  | 3.800   |
| MC100#50820 | 101.6 | 4.000   |
| MC100#50821 | 106.7 | 4.200   |
| MC100#50822 | 111.8 | 4.400   |
| MC100#50823 | 116.8 | 4.600   |
| MC100#50824 | 121.9 | 4.800   |

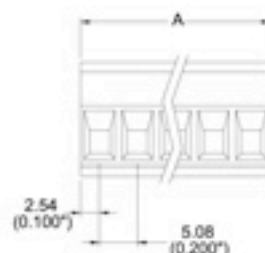
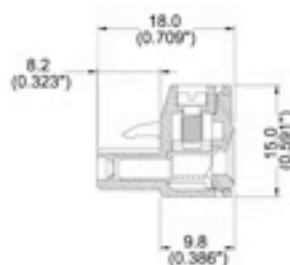

Note:

Screw Plating: Changes are available upon request

Cage Clamp: MC 100- : Brass

Pitch: 7.62mm(0.300inch)

- **Description:**
- Pitch : 7.62mm (0.300inch)

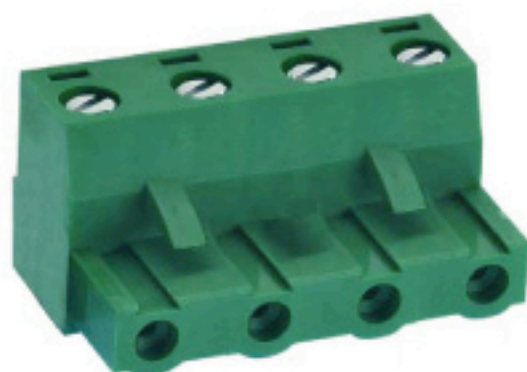
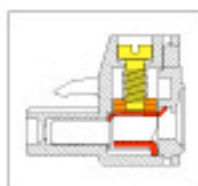

## SPECIFICATIONS

|             |                       |                     | CUL                         | VDE                    |
|-------------|-----------------------|---------------------|-----------------------------|------------------------|
| 負載電壓        | Rated Voltage         | Bemessungsspannung  | AC 300V                     | AC 400V                |
| 負載電流        | Rated Current         | Bemessungsstrom     | 16A                         | 16A                    |
| 電線線徑        | Wire Size             | Leitergrößen        | 24~14AWG                    | 0.2~2.5mm <sup>2</sup> |
| 塑膠本體        | Housing Material      | Isolierstofftyp     | Polyamide66(UL94V-0)        |                        |
| 押線圈         | Cage Clamp            | Klemmkörper         | Steel, Ni plated            |                        |
| 導電夾片        | Contact               | Kontakt             | Phosphor bronze, Tin plated |                        |
| 螺絲          | Screw Size            | Schraubengewinde    | M2.6, steel, Zinc plated    |                        |
| 操作溫度        | Operating Temperature | Umgebungstemperatur | -40°C to + 105°C            |                        |
| 扭力          | Torque                | Anzugsmoment        | 4.5 lb-inch                 |                        |
| UL File No. | E167040               |                     |                             |                        |

TABLE

| Item No.    | A(mm) | A(inch) |
|-------------|-------|---------|
| MC100#76202 | 13.2  | 0.520   |
| MC100#76203 | 20.8  | 0.820   |
| MC100#76204 | 28.5  | 1.120   |
| MC100#76205 | 36.1  | 1.420   |
| MC100#76206 | 43.7  | 1.720   |
| MC100#76207 | 51.3  | 2.020   |
| MC100#76208 | 58.9  | 2.320   |
| MC100#76209 | 66.6  | 2.620   |
| MC100#76210 | 74.2  | 2.920   |
| MC100#76211 | 81.8  | 3.220   |
| MC100#76212 | 89.4  | 3.520   |
| MC100#76213 | 97.0  | 3.820   |
| MC100#76214 | 104.7 | 4.120   |
| MC100#76215 | 112.3 | 4.420   |
| MC100#76216 | 119.9 | 4.720   |

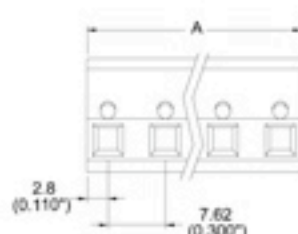
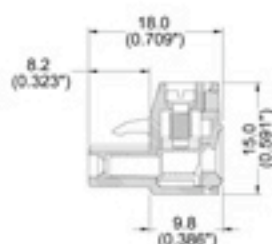

### Note:

Screw Plating: Changes are available upon request  
Cage Clamp: MC 100-: Brass

# MC 101-500 Pluggable terminal block with flanges



Pitch: 5.00mm(0.197inch)



## SPECIFICATIONS

|             |                       |                     | CUL                         | VDE                  |
|-------------|-----------------------|---------------------|-----------------------------|----------------------|
| 負載電壓        | Rated Voltage         | Bemessungsspannung  | AC 300V                     | AC 380V              |
| 負載電流        | Rated Current         | Bemessungsstrom     | 16A                         | 16A                  |
| 電線線徑        | Wire Size             | Leitergrößen        | 24~12AWG                    | 0.2~4mm <sup>2</sup> |
| 塑膠本體        | Housing Material      | Isolierstofftyp     | Polyamide66(UL94V-0)        |                      |
| 押線圈         | Cage Clamp            | Klemmkörper         | Brass, Ni plated            |                      |
| 導電夾片        | Contact               | Kontakt             | Phosphor bronze, Tin plated |                      |
| 螺絲          | Screw Size            | Schraubengewinde    | M3.0, steel, Zinc plated    |                      |
| 操作溫度        | Operating Temperature | Umgebungstemperatur | -40°C to + 105°C            |                      |
| 扭力          | Torque                | Anzugsmoment        | 7.0 lb-inch                 |                      |
| UL File No. | E167040               |                     |                             |                      |

## TABLE

| Item No.    | A(mm) | A(inch) |
|-------------|-------|---------|
| MC101-50002 | 20.0  | 0.787   |
| MC101-50003 | 25.0  | 0.984   |
| MC101-50004 | 30.0  | 1.181   |
| MC101-50005 | 35.0  | 1.378   |
| MC101-50006 | 40.0  | 1.575   |
| MC101-50007 | 45.0  | 1.772   |
| MC101-50008 | 50.0  | 1.969   |
| MC101-50009 | 55.0  | 2.165   |
| MC101-50010 | 60.0  | 2.362   |
| MC101-50011 | 65.0  | 2.559   |
| MC101-50012 | 70.0  | 2.756   |
| MC101-50013 | 75.0  | 2.953   |
| MC101-50014 | 80.0  | 3.150   |
| MC101-50015 | 85.0  | 3.346   |
| MC101-50016 | 90.0  | 3.543   |
| MC101-50017 | 95.0  | 3.740   |
| MC101-50018 | 100.0 | 3.937   |
| MC101-50019 | 105.0 | 4.134   |
| MC101-50020 | 110.0 | 4.331   |
| MC101-50021 | 115.0 | 4.528   |
| MC101-50022 | 120.0 | 4.724   |

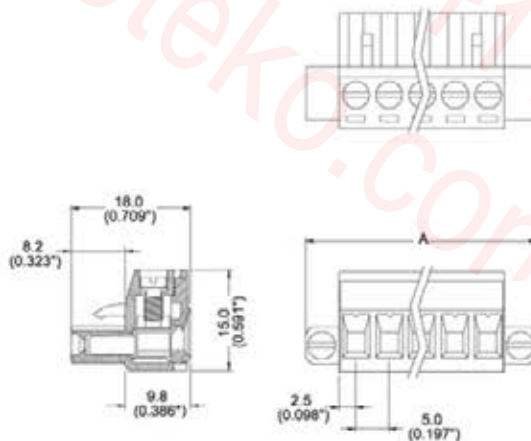

Note:  
Screw Plating: Changes are available upon request  
Cage Clamp: MC 101 # : Steel

# MC 101-508 Pluggable terminal block with flanges



Pitch: 5.08mm(0.200inch)



## SPECIFICATIONS

|             |                       |                     | CUL                         | VDE                  |
|-------------|-----------------------|---------------------|-----------------------------|----------------------|
| 負載電壓        | Rated Voltage         | Bemessungsspannung  | AC 300V                     | AC 380V              |
| 負載電流        | Rated Current         | Bemessungsstrom     | 16A                         | 16A                  |
| 電線線徑        | Wire Size             | Leitergrößen        | 24~12AWG                    | 0.2~4mm <sup>2</sup> |
| 塑膠本體        | Housing Material      | Isolierstofftyp     | Polyamide66(UL94V-0)        |                      |
| 押線圈         | Cage Clamp            | Klemmkörper         | Brass, Ni plated            |                      |
| 導電夾片        | Contact               | Kontakt             | Phosphor bronze, Tin plated |                      |
| 螺絲          | Screw Size            | Schraubengewinde    | M3.0, steel, Zinc plated    |                      |
| 操作溫度        | Operating Temperature | Umgebungstemperatur | -40°C to + 105°C            |                      |
| 扭力          | Torque                | Anzugsmoment        | 7.0 lb-inch                 |                      |
| UL File No. | E167040               |                     |                             |                      |

TABLE

| Item No.    | A(mm) | A(inch) |
|-------------|-------|---------|
| MC101-50802 | 20.3  | 0.800   |
| MC101-50803 | 25.4  | 1.000   |
| MC101-50804 | 30.5  | 1.200   |
| MC101-50805 | 35.6  | 1.400   |
| MC101-50806 | 40.6  | 1.600   |
| MC101-50807 | 45.7  | 1.800   |
| MC101-50808 | 50.8  | 2.000   |
| MC101-50809 | 55.9  | 2.200   |
| MC101-50810 | 61.0  | 2.400   |
| MC101-50811 | 66.0  | 2.600   |
| MC101-50812 | 71.1  | 2.800   |
| MC101-50813 | 76.2  | 3.000   |
| MC101-50814 | 81.3  | 3.200   |
| MC101-50815 | 86.4  | 3.400   |
| MC101-50816 | 91.4  | 3.600   |
| MC101-50817 | 96.5  | 3.800   |
| MC101-50818 | 101.6 | 4.000   |
| MC101-50819 | 106.7 | 4.200   |
| MC101-50820 | 111.8 | 4.400   |
| MC101-50821 | 116.8 | 4.600   |
| MC101-50822 | 121.9 | 4.800   |

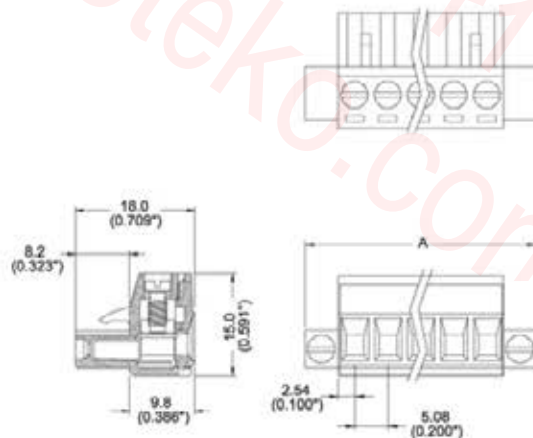

Note:  
Screw Plating: Changes are available upon request  
Cage Clamp: MC 101# : Steel



# MC 101-762 Pluggable terminal block with flanges



Pitch: 7.62mm(0.300inch)



## SPECIFICATIONS

|             |                       |                     | CUL                         | VDE                    |
|-------------|-----------------------|---------------------|-----------------------------|------------------------|
| 負載電壓        | Rated Voltage         | Bemessungsspannung  | AC 300V                     | AC 400V                |
| 負載電流        | Rated Current         | Bemessungsstrom     | 15A                         | 16A                    |
| 電線線徑        | Wire Size             | Leitergrößen        | 24~12AWG                    | 0.2~2.5mm <sup>2</sup> |
| 塑膠本體        | Housing Material      | Isolierstofftyp     | Polyamide66(UL94V-0)        |                        |
| 押線圈         | Cage Clamp            | Klemmkörper         | Brass, Ni plated            |                        |
| 導電夾片        | Contact               | Kontakt             | Phosphor bronze, Tin plated |                        |
| 螺絲          | Screw Size            | Schraubengewinde    | M3.0, steel, Zinc plated    |                        |
| 操作溫度        | Operating Temperature | Umgebungstemperatur | -40°C to + 105°C            |                        |
| 扭力          | Torque                | Anzugsmoment        | 4.5 lb-inch                 |                        |
| UL File No. | E167040               |                     |                             |                        |

## TABLE

| Item No.    | A(mm) | A(inch) |
|-------------|-------|---------|
| MC101-76202 | 24.9  | 0.980   |
| MC101-76203 | 32.5  | 1.280   |
| MC101-76204 | 40.1  | 1.580   |
| MC101-76205 | 47.8  | 1.880   |
| MC101-76206 | 55.4  | 2.180   |
| MC101-76207 | 63.0  | 2.480   |
| MC101-76208 | 70.6  | 2.780   |
| MC101-76209 | 78.2  | 3.080   |
| MC101-76210 | 85.9  | 3.380   |
| MC101-76211 | 93.5  | 3.680   |
| MC101-76212 | 101.1 | 3.980   |
| MC101-76213 | 108.7 | 4.280   |
| MC101-76214 | 116.3 | 4.580   |
| MC101-76215 | 124.0 | 4.880   |
| MC101-76216 | 131.6 | 5.180   |

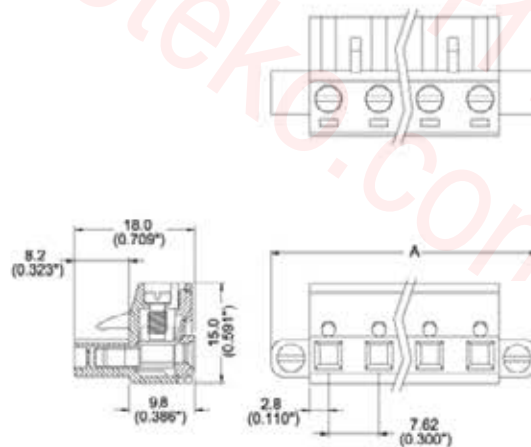

Note:  
Screw Plating: Changes are available upon request  
Cage Clamp: MC 101 # : Steel

Pitch: 5.00mm(0.197inch)

- **Description:**
- Pitch : 5.00mm (0.197inch)

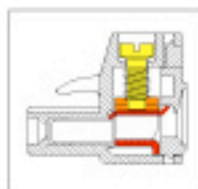

## SPECIFICATIONS

|      |                       |                     | CUL                         | VDE                  |
|------|-----------------------|---------------------|-----------------------------|----------------------|
| 負載電壓 | Rated Voltage         | Bemessungsspannung  | AC 300V                     | AC 400V              |
| 負載電流 | Rated Current         | Bemessungsstrom     | 16A                         | 16A                  |
| 電線線徑 | Wire Size             | Leitergrößen        | 24~12AWG                    | 0.2~4mm <sup>2</sup> |
| 塑膠本體 | Housing Material      | Isolierstofftyp     | Polyamide66(UL94V-0)        |                      |
| 押線圈  | Cage Clamp            | Klemmkörper         | Steel, Ni plated            |                      |
| 導電夾片 | Contact               | Kontakt             | Phosphor bronze, Tin plated |                      |
| 螺絲   | Screw Size            | Schraubengewinde    | M2.6, steel, Zinc plated    |                      |
| 操作溫度 | Operating Temperature | Umgebungstemperatur | -40°C to + 105°C            |                      |
| 扭力   | Torque                | Anzugsmoment        | 7.0 lb-inch                 |                      |

UL File No. E167040

### TABLE

| Item No.    | A(mm) | A(inch) |
|-------------|-------|---------|
| MC101#50002 | 20.0  | 0.787   |
| MC101#50003 | 25.0  | 0.984   |
| MC101#50004 | 30.0  | 1.181   |
| MC101#50005 | 35.0  | 1.378   |
| MC101#50006 | 40.0  | 1.575   |
| MC101#50007 | 45.0  | 1.772   |
| MC101#50008 | 50.0  | 1.969   |
| MC101#50009 | 55.0  | 2.165   |
| MC101#50010 | 60.0  | 2.362   |
| MC101#50011 | 65.0  | 2.559   |
| MC101#50012 | 70.0  | 2.756   |
| MC101#50013 | 75.0  | 2.953   |
| MC101#50014 | 80.0  | 3.150   |
| MC101#50015 | 85.0  | 3.346   |
| MC101#50016 | 90.0  | 3.543   |
| MC101#50017 | 95.0  | 3.740   |
| MC101#50018 | 100.0 | 3.937   |
| MC101#50019 | 105.0 | 4.134   |
| MC101#50020 | 110.0 | 4.331   |
| MC101#50021 | 115.0 | 4.528   |
| MC101#50022 | 120.0 | 4.724   |

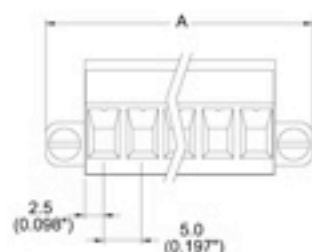
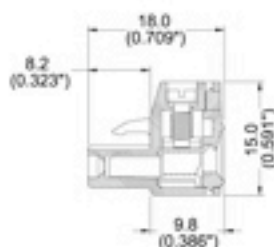

Note:

Screw Plating: Changes are available upon request

Cage Clamp: MC 101- : Brass

Pitch: 5.08mm(0.200inch)

- **Description:**
- Pitch : 5.08mm (0.200inch)

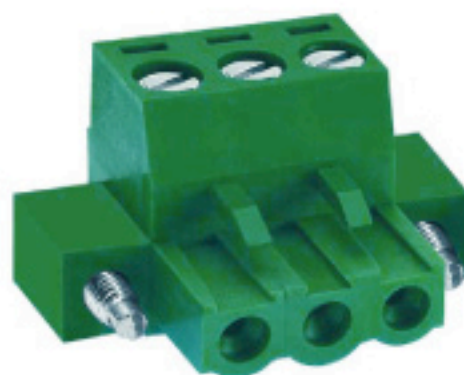
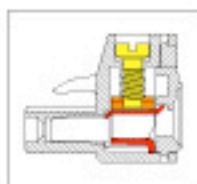

## SPECIFICATIONS

|             |                       |                     | CUL                         | VDE                  |
|-------------|-----------------------|---------------------|-----------------------------|----------------------|
| 負載電壓        | Rated Voltage         | Bemessungsspannung  | AC 300V                     | AC 400V              |
| 負載電流        | Rated Current         | Bemessungsstrom     | 16A                         | 16A                  |
| 電線線徑        | Wire Size             | Leitergrößen        | 24~12AWG                    | 0.2~4mm <sup>2</sup> |
| 塑膠本體        | Housing Material      | Isolierstofftyp     | Polyamide66(UL94V-0)        |                      |
| 押線圈         | Cage Clamp            | Klemmkörper         | Steel, Ni plated            |                      |
| 導電夾片        | Contact               | Kontakt             | Phosphor bronze, Tin plated |                      |
| 螺絲          | Screw Size            | Schraubengewinde    | M2.6, steel, Zinc plated    |                      |
| 操作溫度        | Operating Temperature | Umgebungstemperatur | -40°C to + 105°C            |                      |
| 扭力          | Torque                | Anzugsmoment        | 7.0 lb-inch                 |                      |
| UL File No. | E167040               |                     |                             |                      |

TABLE

| Item No.    | A(mm) | A(inch) |
|-------------|-------|---------|
| MC100#50802 | 10.2  | 0.400   |
| MC100#50803 | 15.2  | 0.600   |
| MC100#50804 | 20.3  | 0.800   |
| MC100#50805 | 25.4  | 1.000   |
| MC100#50806 | 30.5  | 1.200   |
| MC100#50807 | 35.6  | 1.400   |
| MC100#50808 | 40.6  | 1.600   |
| MC100#50809 | 45.7  | 1.800   |
| MC100#50810 | 50.8  | 2.000   |
| MC100#50811 | 55.9  | 2.200   |
| MC100#50812 | 61.0  | 2.400   |
| MC100#50813 | 66.0  | 2.600   |
| MC100#50814 | 71.1  | 2.800   |
| MC100#50815 | 76.2  | 3.000   |
| MC100#50816 | 81.3  | 3.200   |
| MC100#50817 | 86.4  | 3.400   |
| MC100#50818 | 91.4  | 3.600   |
| MC100#50819 | 96.5  | 3.800   |
| MC100#50820 | 101.6 | 4.000   |
| MC100#50821 | 106.7 | 4.200   |
| MC100#50822 | 111.8 | 4.400   |
| MC100#50823 | 116.8 | 4.600   |
| MC100#50824 | 121.9 | 4.800   |

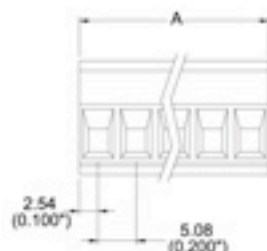
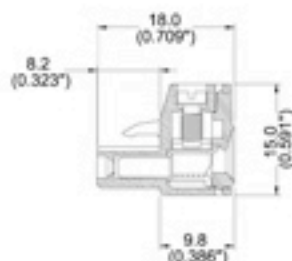

Note:

Screw Plating: Changes are available upon request

Cage Clamp: MC 100- : Brass

Pitch: 7.62mm(0.300inch)

- **Description:**
- Pitch : 7.62mm (0.300inch)

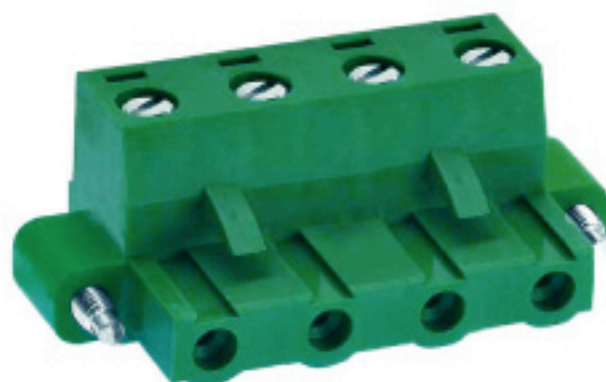
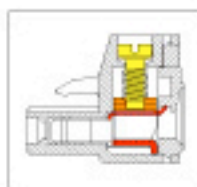

## SPECIFICATIONS

|             |                       |                     | CUL                         | VDE                    |
|-------------|-----------------------|---------------------|-----------------------------|------------------------|
| 負載電壓        | Rated Voltage         | Bemessungsspannung  | AC 300V                     | AC 400V                |
| 負載電流        | Rated Current         | Bemessungsstrom     | 15A                         | 16A                    |
| 電線線徑        | Wire Size             | Leitergrößen        | 24~12AWG                    | 0.2~2.5mm <sup>2</sup> |
| 塑膠本體        | Housing Material      | Isolierstofftyp     | Polyamide66(UL94V-0)        |                        |
| 押線圈         | Cage Clamp            | Klemmkörper         | Steel, Ni plated            |                        |
| 導電夾片        | Contact               | Kontakt             | Phosphor bronze, Tin plated |                        |
| 螺絲          | Screw Size            | Schraubengewinde    | M2.6, steel, Zinc plated    |                        |
| 操作溫度        | Operating Temperature | Umgebungstemperatur | -40°C to + 105°C            |                        |
| 扭力          | Torque                | Anzugsmoment        | 4.5 lb-inch                 |                        |
| UL File No. | E167040               |                     |                             |                        |

TABLE

| Item No.    | A(mm) | A(inch) |
|-------------|-------|---------|
| MC101#76202 | 24.9  | 0.980   |
| MC101#76203 | 32.5  | 1.280   |
| MC101#76204 | 40.1  | 1.580   |
| MC101#76205 | 47.8  | 1.880   |
| MC101#76206 | 55.4  | 2.180   |
| MC101#76207 | 63.0  | 2.480   |
| MC101#76208 | 70.6  | 2.780   |
| MC101#76209 | 78.2  | 3.080   |
| MC101#76210 | 85.9  | 3.380   |
| MC101#76211 | 93.5  | 3.680   |
| MC101#76212 | 101.1 | 3.980   |
| MC101#76213 | 108.7 | 4.280   |
| MC101#76214 | 116.3 | 4.580   |
| MC101#76215 | 124.0 | 4.880   |
| MC101#76216 | 131.6 | 5.180   |

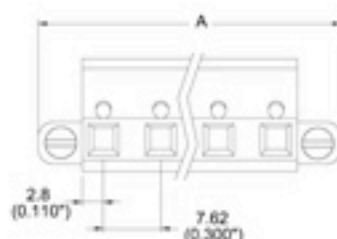
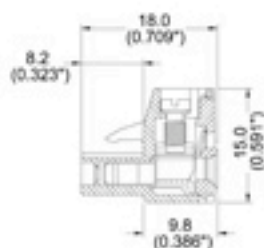

Note:

Screw Plating: Changes are available upon request

Cage Clamp: MC 101- : Brass

Pitch: 5.08mm(0.200inch)

- **Description:**
- Pitch : 5.08mm (0.200inch)

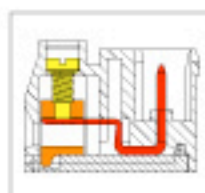
C **RU**® US**SPECIFICATIONS**

|      |                       |                     |                          |
|------|-----------------------|---------------------|--------------------------|
| 負載電壓 | Rated Voltage         | Bemessungsspannung  | CUL<br>AC 300V           |
| 負載電流 | Rated Current         | Bemessungsstrom     | 10A                      |
| 電線線徑 | Wire Size             | Leitergrößen        | 24~12AWG                 |
| 塑膠本體 | Housing Material      | Isolierstofftyp     | Polyamide66(UL94V-0)     |
| 押線圈  | Cage Clamp            | Klemmkörper         | Brass, Ni plated         |
| 導電夾片 | Contact               | Kontakt             | Brass, Tin plated        |
| 螺絲   | Screw Size            | Schraubengewinde    | M2.6, steel, Zinc plated |
| 操作溫度 | Operating Temperature | Umgebungstemperatur | -40°C to + 120°C         |
| 扭力   | Torque                | Anzugsmoment        | 4.5 lb-inch              |

TABLE

| Item No.    | A(mm)  | A(inch) |
|-------------|--------|---------|
| MC122-50802 | 11.44  | 0.450   |
| MC122-50803 | 16.52  | 0.650   |
| MC122-50804 | 21.60  | 0.850   |
| MC122-50805 | 26.68  | 1.050   |
| MC122-50806 | 31.76  | 1.250   |
| MC122-50807 | 36.84  | 1.450   |
| MC122-50808 | 41.92  | 1.650   |
| MC122-50809 | 47.00  | 1.850   |
| MC122-50810 | 52.08  | 2.050   |
| MC122-50811 | 57.16  | 2.250   |
| MC122-50812 | 62.24  | 2.450   |
| MC122-50813 | 67.32  | 2.650   |
| MC122-50814 | 72.40  | 2.850   |
| MC122-50815 | 77.48  | 3.050   |
| MC122-50816 | 82.56  | 3.250   |
| MC122-50817 | 87.64  | 3.450   |
| MC122-50818 | 92.72  | 3.650   |
| MC122-50819 | 97.80  | 3.850   |
| MC122-50820 | 102.88 | 4.050   |

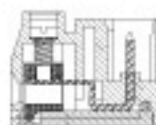
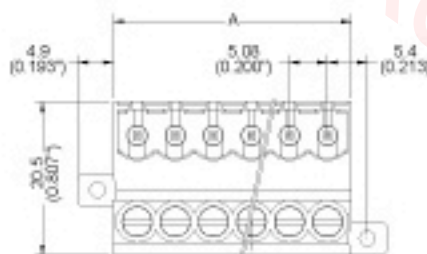

Pitch: 5.08mm(0.200inch)

- **Description:**
- Pitch : 5.08mm (0.200inch)

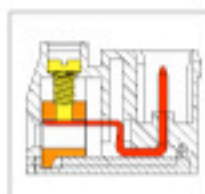



## SPECIFICATIONS

|      |                       |                     | CUL                      | VDE |
|------|-----------------------|---------------------|--------------------------|-----|
| 負載電壓 | Rated Voltage         | Bemessungsspannung  | AC 300V                  |     |
| 負載電流 | Rated Current         | Bemessungsstrom     | 10A                      |     |
| 電線線徑 | Wire Size             | Leitergrößen        | 24~12AWG                 |     |
| 塑膠本體 | Housing Material      | Isolierstofftyp     | Polyamide66(UL94V-0)     |     |
| 押線圈  | Cage Clamp            | Klemmkörper         | Brass, Ni plated         |     |
| 導電夾片 | Contact               | Kontakt             | Brass, Tin plated        |     |
| 螺絲   | Screw Size            | Schraubengewinde    | M2.6, steel, Zinc plated |     |
| 操作溫度 | Operating Temperature | Umgebungstemperatur | -40°C to + 120°C         |     |
| 扭力   | Torque                | Anzugsmoment        | 4.5 lb-inch              |     |

### TABLE

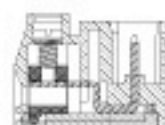
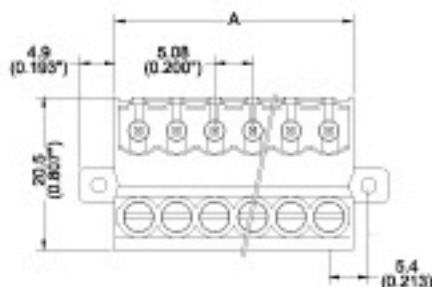
| Item No.    | A(mm)  | A(inch) |
|-------------|--------|---------|
| MC123-50802 | 11.44  | 0.450   |
| MC123-50803 | 16.52  | 0.650   |
| MC123-50804 | 21.60  | 0.850   |
| MC123-50805 | 26.68  | 1.050   |
| MC123-50806 | 31.76  | 1.250   |
| MC123-50807 | 36.84  | 1.450   |
| MC123-50808 | 41.92  | 1.650   |
| MC123-50809 | 47.00  | 1.850   |
| MC123-50810 | 52.08  | 2.050   |
| MC123-50811 | 57.16  | 2.250   |
| MC123-50812 | 62.24  | 2.450   |
| MC123-50813 | 67.32  | 2.650   |
| MC123-50814 | 72.40  | 2.850   |
| MC123-50815 | 77.48  | 3.050   |
| MC123-50816 | 82.56  | 3.250   |
| MC123-50817 | 87.64  | 3.450   |
| MC123-50818 | 92.72  | 3.650   |
| MC123-50819 | 97.80  | 3.850   |
| MC123-50820 | 102.88 | 4.050   |



Pitch: 7.50mm(0.295inch)

- **Description:**
- Pitch : 7.50mm (0.295inch)

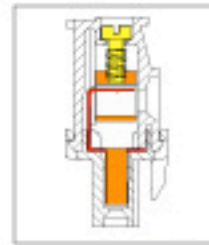



## SPECIFICATIONS

|      |                       |                     | CUL                         |
|------|-----------------------|---------------------|-----------------------------|
| 負載電壓 | Rated Voltage         | Bemessungsspannung  | AC 300V                     |
| 負載電流 | Rated Current         | Bemessungsstrom     | 16A                         |
| 電線線徑 | Wire Size             | Leitergrößen        | 24~12AWG                    |
| 塑膠本體 | Housing Material      | Isolierstofftyp     | Polyamide66(UL94V-0)        |
| 押線圈  | Cage Clamp            | Klemmkörper         | Brass, Tin plated           |
| 導電夾片 | Contact               | Kontakt             | Phosphor bronze, Tin plated |
| 螺絲   | Screw Size            | Schraubengewinde    | M2.6, steel, Ni plated      |
| 操作溫度 | Operating Temperature | Umgebungstemperatur | -40°C to + 105°C            |
| 扭力   | Torque                | Anzugsmoment        | 7 lb-inch                   |

### TABLE

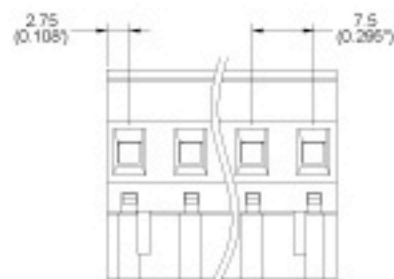
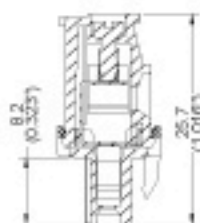
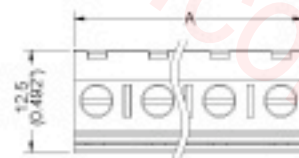
| Item No.    | A(mm)  | A(inch) |
|-------------|--------|---------|
| MC200-75002 | 13.00  | 0.512   |
| MC200-75003 | 20.50  | 0.807   |
| MC200-75004 | 28.00  | 1.102   |
| MC200-75005 | 35.50  | 1.398   |
| MC200-75006 | 43.00  | 1.698   |
| MC200-75007 | 50.50  | 1.988   |
| MC200-75008 | 58.00  | 2.283   |
| MC200-75009 | 65.50  | 2.579   |
| MC200-75010 | 73.00  | 2.874   |
| MC200-75011 | 80.50  | 3.169   |
| MC200-75012 | 88.00  | 3.465   |
| MC200-75013 | 95.50  | 3.760   |
| MC200-75014 | 103.00 | 4.055   |



# MC 200-E1

Pluggable terminal block



Pitch: 5.00mm(0.197inch)



## SPECIFICATIONS

|             |                       |                     | CUL                         | VDE                  |
|-------------|-----------------------|---------------------|-----------------------------|----------------------|
| 負載電壓        | Rated Voltage         | Bemessungsspannung  | AC 300V                     | AC 380V              |
| 負載電流        | Rated Current         | Bemessungsstrom     | 16A                         | 16A                  |
| 電線線徑        | Wire Size             | Leitergrößen        | 24~12AWG                    | 0.2~4mm <sup>2</sup> |
| 塑膠本體        | Housing Material      | Isolierstofftyp     | Polyamide66(UL94V-0)        |                      |
| 押線圈         | Cage Clamp            | Klemmkörper         | Brass, Ni plated            |                      |
| 導電夾片        | Contact               | Kontakt             | Phosphor bronze, Tin plated |                      |
| 螺絲          | Screw Size            | Schraubengewinde    | M2.6, steel, Zinc plated    |                      |
| 操作溫度        | Operating Temperature | Umgebungstemperatur | -40°C to + 105°C            |                      |
| 扭力          | Torque                | Anzugsmoment        | 7 lb-inch                   |                      |
| UL File No. | E167040               |                     |                             |                      |

TABLE

| Item No.   | A(mm) | A(Inch) |
|------------|-------|---------|
| MC200-E102 | 10.0  | 0.394   |
| MC200-E103 | 15.0  | 0.591   |
| MC200-E104 | 20.0  | 0.787   |
| MC200-E105 | 25.0  | 0.984   |
| MC200-E106 | 30.0  | 1.181   |
| MC200-E107 | 35.0  | 1.378   |
| MC200-E108 | 40.0  | 1.575   |
| MC200-E109 | 45.0  | 1.772   |
| MC200-E110 | 50.0  | 1.969   |
| MC200-E111 | 55.0  | 2.165   |
| MC200-E112 | 60.0  | 2.362   |
| MC200-E113 | 65.0  | 2.559   |
| MC200-E114 | 70.0  | 2.756   |
| MC200-E115 | 75.0  | 2.953   |
| MC200-E116 | 80.0  | 3.150   |
| MC200-E117 | 85.0  | 3.346   |
| MC200-E118 | 90.0  | 3.543   |
| MC200-E119 | 95.0  | 3.740   |
| MC200-E120 | 100.0 | 3.937   |
| MC200-E121 | 105.0 | 4.134   |
| MC200-E122 | 110.0 | 4.331   |
| MC200-E123 | 115.0 | 4.528   |
| MC200-E124 | 120.0 | 4.724   |

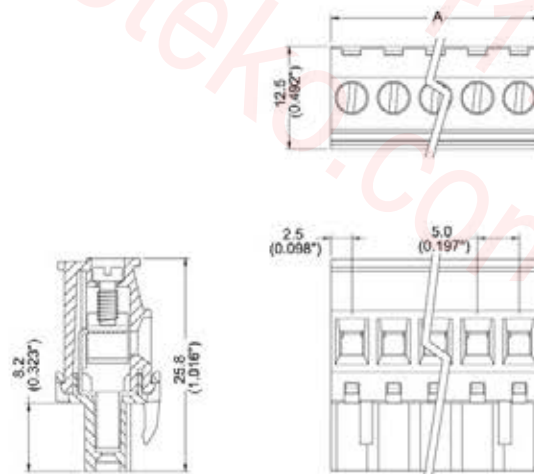

Note:  
Screw Plating:Changes are available upon request



# MC 200-F1

Pluggable terminal block



Pitch: 5.08mm(0.200inch)



## SPECIFICATIONS

|             |                       |                     | CUL                         | VDE                  |
|-------------|-----------------------|---------------------|-----------------------------|----------------------|
| 負載電壓        | Rated Voltage         | Bemessungsspannung  | AC 300V                     | AC 380V              |
| 負載電流        | Rated Current         | Bemessungsstrom     | 16A                         | 16A                  |
| 電線線徑        | Wire Size             | Leitergrößen        | 24~12AWG                    | 0.2~4mm <sup>2</sup> |
| 塑膠本體        | Housing Material      | Isolierstofftyp     | Polyamide66(UL94V-0)        |                      |
| 押線圈         | Cage Clamp            | Klemmkörper         | Brass, Ni plated            |                      |
| 導電夾片        | Contact               | Kontakt             | Phosphor bronze, Tin plated |                      |
| 螺絲          | Screw Size            | Schraubengewinde    | M2.6, steel, Zinc plated    |                      |
| 操作溫度        | Operating Temperature | Umgebungstemperatur | -40°C to + 105°C            |                      |
| 扭力          | Torque                | Anzugsmoment        | 7.0 lb-inch                 |                      |
| UL File No. | E167040               |                     |                             |                      |

## TABLE

| Item No.   | A(mm) | A(inch) |
|------------|-------|---------|
| MC200-F102 | 10.2  | 0.400   |
| MC200-F103 | 15.2  | 0.600   |
| MC200-F104 | 20.3  | 0.800   |
| MC200-F105 | 25.4  | 1.000   |
| MC200-F106 | 30.5  | 1.200   |
| MC200-F107 | 35.6  | 1.400   |
| MC200-F108 | 40.6  | 1.600   |
| MC200-F109 | 45.7  | 1.800   |
| MC200-F110 | 50.8  | 2.000   |
| MC200-F111 | 55.9  | 2.200   |
| MC200-F112 | 61.0  | 2.400   |
| MC200-F113 | 66.0  | 2.600   |
| MC200-F114 | 71.1  | 2.800   |
| MC200-F115 | 76.2  | 3.000   |
| MC200-F116 | 81.3  | 3.200   |
| MC200-F117 | 86.4  | 3.400   |
| MC200-F118 | 91.4  | 3.600   |
| MC200-F119 | 96.5  | 3.800   |
| MC200-F120 | 101.6 | 4.000   |
| MC200-F121 | 106.7 | 4.200   |
| MC200-F122 | 111.8 | 4.400   |
| MC200-F123 | 116.8 | 4.600   |
| MC200-F124 | 121.9 | 4.800   |

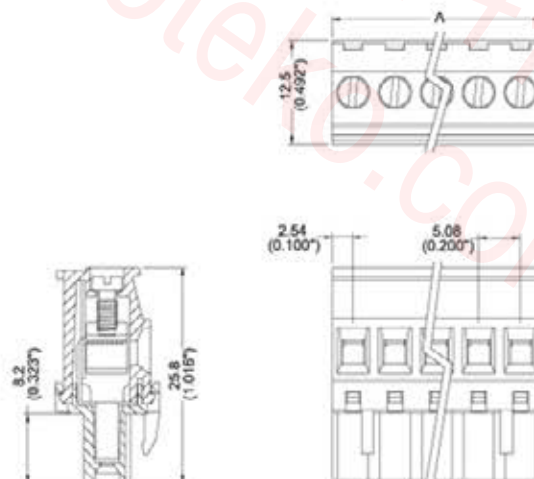

Note:  
Screw Plating: Changes are available upon request

# MC 201-E1 Pluggable terminal block with flanges **DECA**

Pitch: 5.00mm(0.197inch)



## SPECIFICATIONS

|             |                       |                     | CUL                         | VDE                  |
|-------------|-----------------------|---------------------|-----------------------------|----------------------|
| 負載電壓        | Rated Voltage         | Bemessungsspannung  | AC 300V                     | AC 380V              |
| 負載電流        | Rated Current         | Bemessungsstrom     | 16A                         | 16A                  |
| 電線線徑        | Wire Size             | Leitergrößen        | 24~12AWG                    | 0.2~4mm <sup>2</sup> |
| 塑膠本體        | Housing Material      | Isolierstofftyp     | Polyamide66(UL94V-0)        |                      |
| 押線圈         | Cage Clamp            | Klemmkörper         | Brass, Ni plated            |                      |
| 導電夾片        | Contact               | Kontakt             | Phosphor bronze, Tin plated |                      |
| 螺絲          | Screw Size            | Schraubengewinde    | M2.6, steel, Zinc plated    |                      |
| 操作溫度        | Operating Temperature | Umgebungstemperatur | -40°C to + 105°C            |                      |
| 扭力          | Torque                | Anzugsmoment        | 7.0 lb-inch                 |                      |
| UL File No. | E167040               |                     |                             |                      |

TABLE

| Item No.   | A(mm) | A(inch) |
|------------|-------|---------|
| MC201-E102 | 20.0  | 0.787   |
| MC201-E103 | 25.0  | 0.984   |
| MC201-E104 | 30.0  | 1.181   |
| MC201-E105 | 35.0  | 1.378   |
| MC201-E106 | 40.0  | 1.575   |
| MC201-E107 | 45.0  | 1.772   |
| MC201-E108 | 50.0  | 1.969   |
| MC201-E109 | 55.0  | 2.165   |
| MC201-E110 | 60.0  | 2.362   |
| MC201-E111 | 65.0  | 2.559   |
| MC201-E112 | 70.0  | 2.755   |
| MC201-E113 | 75.0  | 2.952   |
| MC201-E114 | 80.0  | 3.149   |
| MC201-E115 | 85.0  | 3.346   |
| MC201-E116 | 90.0  | 3.543   |
| MC201-E117 | 95.0  | 3.740   |
| MC201-E118 | 100.0 | 3.937   |
| MC201-E119 | 105.0 | 4.133   |
| MC201-E120 | 110.0 | 4.331   |
| MC201-E121 | 115.0 | 4.527   |
| MC201-E122 | 120.0 | 4.724   |

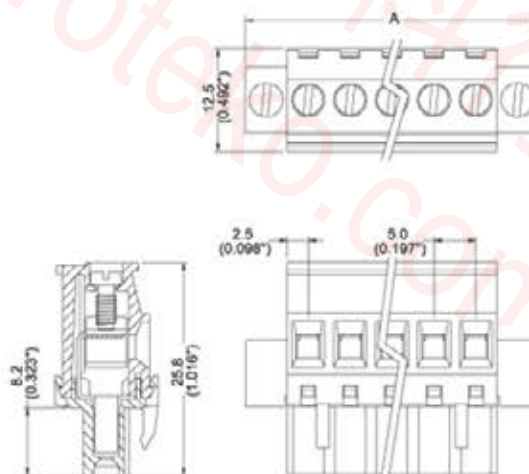

Note:  
Screw Plating: Changes are available upon request

# MC 201-F1

Pluggable terminal block with flanges



Pitch: 5.08mm(0.200inch)



## SPECIFICATIONS

|             |                       |                     | CUL                         | VDE                  |
|-------------|-----------------------|---------------------|-----------------------------|----------------------|
| 負載電壓        | Rated Voltage         | Bemessungsspannung  | AC 300V                     | AC 380V              |
| 負載電流        | Rated Current         | Bemessungsstrom     | 16A                         | 16A                  |
| 電線線徑        | Wire Size             | Leitergrößen        | 24~12AWG                    | 0.2~4mm <sup>2</sup> |
| 塑膠本體        | Housing Material      | Isolierstofftyp     | Polyamide66(UL94V-0)        |                      |
| 押線圈         | Cage Clamp            | Klemmkörper         | Brass, Ni plated            |                      |
| 導電夾片        | Contact               | Kontakt             | Phosphor bronze, Tin plated |                      |
| 螺絲          | Screw Size            | Schraubengewinde    | M2.6, steel, Zinc plated    |                      |
| 操作溫度        | Operating Temperature | Umgebungstemperatur | -40°C to + 105°C            |                      |
| 扭力          | Torque                | Anzugsmoment        | 7.0 lb-inch                 |                      |
| UL File No. | E167040               |                     |                             |                      |

## TABLE

| Item No.   | A(mm) | A(inch) |
|------------|-------|---------|
| MC201-F102 | 20.3  | 0.800   |
| MC201-F103 | 25.4  | 1.000   |
| MC201-F104 | 30.5  | 1.200   |
| MC201-F105 | 35.6  | 1.400   |
| MC201-F106 | 40.6  | 1.600   |
| MC201-F107 | 45.7  | 1.800   |
| MC201-F108 | 50.8  | 2.000   |
| MC201-F109 | 55.9  | 2.200   |
| MC201-F110 | 61.0  | 2.400   |
| MC201-F111 | 66.0  | 2.600   |
| MC201-F112 | 71.1  | 2.800   |
| MC201-F113 | 76.2  | 3.000   |
| MC201-F114 | 81.3  | 3.200   |
| MC201-F115 | 86.4  | 3.400   |
| MC201-F116 | 91.4  | 3.600   |
| MC201-F117 | 96.5  | 3.800   |
| MC201-F118 | 101.6 | 4.000   |
| MC201-F119 | 106.7 | 4.200   |
| MC201-F120 | 111.8 | 4.400   |
| MC201-F121 | 116.8 | 4.600   |
| MC201-F122 | 121.9 | 4.800   |

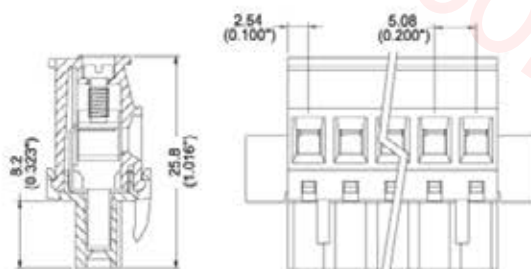
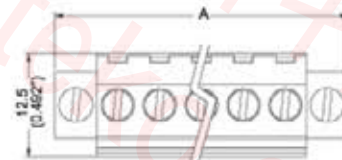

Note:  
Screw Plating: Changes are available upon request

Pitch: 7.50mm(0.295inch)

- **Description:**
- Pitch : 7.50mm (0.295inch)

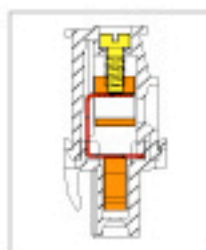



## SPECIFICATIONS

|      |                       |                     | CUL                         |
|------|-----------------------|---------------------|-----------------------------|
| 負載電壓 | Rated Voltage         | Bemessungsspannung  | AC 300V                     |
| 負載電流 | Rated Current         | Bemessungsstrom     | 16A                         |
| 電線線徑 | Wire Size             | Leitergrößen        | 24~12AWG                    |
| 塑膠本體 | Housing Material      | Isolierstofftyp     | Polyamide66(UL94V-0)        |
| 押線圈  | Cage Clamp            | Klemmkörper         | Brass, Tin plated           |
| 導電夾片 | Contact               | Kontakt             | Phosphor bronze, Tin plated |
| 螺絲   | Screw Size            | Schraubengewinde    | M2.6, steel, Ni plated      |
| 操作溫度 | Operating Temperature | Umgebungstemperatur | -40°C to + 105°C            |
| 扭力   | Torque                | Anzugsmoment        | 7 lb-inch                   |

### TABLE

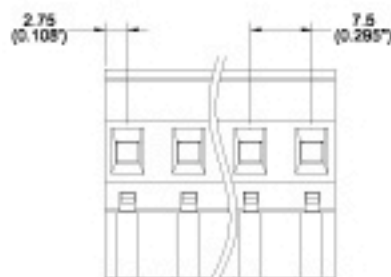
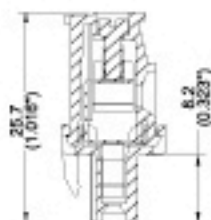
| Item No.    | A(mm)  | A(inch) |
|-------------|--------|---------|
| MC210-75002 | 13.00  | 0.512   |
| MC210-75003 | 20.50  | 0.807   |
| MC210-75004 | 28.00  | 1.102   |
| MC210-75005 | 35.50  | 1.398   |
| MC210-75006 | 43.00  | 1.698   |
| MC210-75007 | 50.50  | 1.988   |
| MC210-75008 | 58.00  | 2.283   |
| MC210-75009 | 65.50  | 2.579   |
| MC210-75010 | 73.00  | 2.874   |
| MC210-75011 | 80.50  | 3.169   |
| MC210-75012 | 88.00  | 3.465   |
| MC210-75013 | 95.50  | 3.760   |
| MC210-75014 | 103.00 | 4.055   |
| MC210-75015 | 110.50 | 4.350   |
| MC210-75016 | 118.00 | 4.645   |
| MC210-75017 | 125.00 | 4.940   |
| MC210-75018 | 132.50 | 5.235   |



# MC 210-E1 Pluggable terminal block



Pitch: 5.00mm(0.197inch)



## SPECIFICATIONS

|             |                       |                     | CUL                         | VDE                  |
|-------------|-----------------------|---------------------|-----------------------------|----------------------|
| 負載電壓        | Rated Voltage         | Bemessungsspannung  | AC 300V                     | AC 380V              |
| 負載電流        | Rated Current         | Bemessungsstrom     | 16A                         | 16A                  |
| 電線線徑        | Wire Size             | Leitergrößen        | 24~12AWG                    | 0.2~4mm <sup>2</sup> |
| 塑膠本體        | Housing Material      | Isolierstofftyp     | Polyamide66(UL94V-0)        |                      |
| 押線圈         | Cage Clamp            | Klemmkörper         | Brass, Ni plated            |                      |
| 導電夾片        | Contact               | Kontakt             | Phosphor bronze, Tin plated |                      |
| 螺絲          | Screw Size            | Schraubengewinde    | M2.6, steel, Zinc plated    |                      |
| 操作溫度        | Operating Temperature | Umgebungstemperatur | -40°C to + 105°C            |                      |
| 扭力          | Torque                | Anzugsmoment        | 7.0 lb-inch                 |                      |
| UL File No. | E167040               |                     |                             |                      |

TABLE

| Item No.   | A(mm) | A(inch) |
|------------|-------|---------|
| MC210-E102 | 10.0  | 0.394   |
| MC210-E103 | 15.0  | 0.591   |
| MC210-E104 | 20.0  | 0.787   |
| MC210-E105 | 25.0  | 0.984   |
| MC210-E106 | 30.0  | 1.181   |
| MC210-E107 | 35.0  | 1.378   |
| MC210-E108 | 40.0  | 1.575   |
| MC210-E109 | 45.0  | 1.772   |
| MC210-E110 | 50.0  | 1.969   |
| MC210-E111 | 55.0  | 2.165   |
| MC210-E112 | 60.0  | 2.362   |
| MC210-E113 | 65.0  | 2.559   |
| MC210-E114 | 70.0  | 2.756   |
| MC210-E115 | 75.0  | 2.953   |
| MC210-E116 | 80.0  | 3.150   |
| MC210-E117 | 85.0  | 3.346   |
| MC210-E118 | 90.0  | 3.543   |
| MC210-E119 | 95.0  | 3.740   |
| MC210-E120 | 100.0 | 3.937   |
| MC210-E121 | 105.0 | 4.134   |
| MC210-E122 | 110.0 | 4.331   |
| MC210-E123 | 115.0 | 4.528   |
| MC210-E124 | 120.0 | 4.724   |

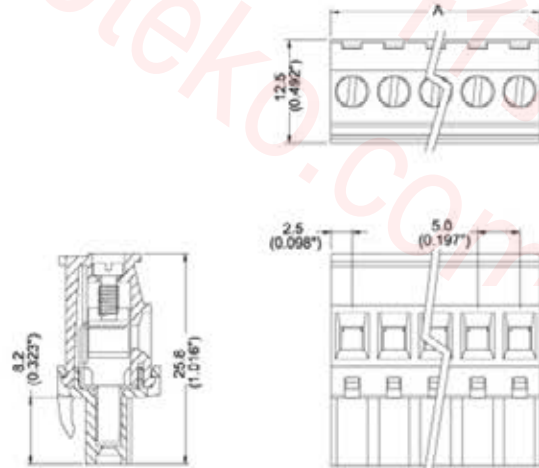

Note:  
Screw Plating: Changes are available upon request

# MC 210-F1

Pluggable terminal block



Pitch: 5.08mm(0.200inch)



## SPECIFICATIONS

|             |                       |                     | CUL                         | VDE                  |
|-------------|-----------------------|---------------------|-----------------------------|----------------------|
| 負載電壓        | Rated Voltage         | Bemessungsspannung  | AC 300V                     | AC 380V              |
| 負載電流        | Rated Current         | Bemessungsstrom     | 16A                         | 16A                  |
| 電線線徑        | Wire Size             | Leitergrößen        | 24~12AWG                    | 0.2~4mm <sup>2</sup> |
| 塑膠本體        | Housing Material      | Isolierstofftyp     | Polyamide66(UL94V-0)        |                      |
| 押線圈         | Cage Clamp            | Klemmkörper         | Brass, Ni plated            |                      |
| 導電夾片        | Contact               | Kontakt             | Phosphor bronze, Tin plated |                      |
| 螺絲          | Screw Size            | Schraubengewinde    | M2.6, steel, Zinc plated    |                      |
| 操作溫度        | Operating Temperature | Umgebungstemperatur | -40°C to + 105°C            |                      |
| 扭力          | Torque                | Anzugsmoment        | 7 lb-inch                   |                      |
| UL File No. | E167040               |                     |                             |                      |

## TABLE

| Item No.   | A(mm) | A(inch) |
|------------|-------|---------|
| MC210-F102 | 10.2  | 0.400   |
| MC210-F103 | 15.2  | 0.600   |
| MC210-F104 | 20.3  | 0.800   |
| MC210-F105 | 25.4  | 1.000   |
| MC210-F106 | 30.5  | 1.200   |
| MC210-F107 | 35.6  | 1.400   |
| MC210-F108 | 40.6  | 1.600   |
| MC210-F109 | 45.7  | 1.800   |
| MC210-F110 | 50.8  | 2.000   |
| MC210-F111 | 55.9  | 2.200   |
| MC210-F112 | 61.0  | 2.400   |
| MC210-F113 | 66.0  | 2.600   |
| MC210-F114 | 71.1  | 2.800   |
| MC210-F115 | 76.2  | 3.000   |
| MC210-F116 | 81.3  | 3.200   |
| MC210-F117 | 86.4  | 3.400   |
| MC210-F118 | 91.4  | 3.600   |
| MC210-F119 | 96.5  | 3.800   |
| MC210-F120 | 101.6 | 4.000   |
| MC210-F121 | 106.7 | 4.200   |
| MC210-F122 | 111.8 | 4.400   |
| MC210-F123 | 116.8 | 4.600   |
| MC210-F124 | 121.9 | 4.800   |

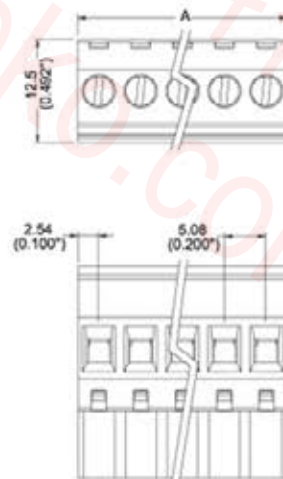
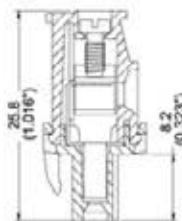

Note:  
Screw Plating: Changes are available upon request

# MC 211-E1 Pluggable terminal block with flanges **DECA**

Pitch: 5.00mm(0.197inch)



## SPECIFICATIONS

|             |                       |                     | CUL                         | VDE                  |
|-------------|-----------------------|---------------------|-----------------------------|----------------------|
| 負載電壓        | Rated Voltage         | Bemessungsspannung  | AC 300V                     | AC 380V              |
| 負載電流        | Rated Current         | Bemessungsstrom     | 16A                         | 16A                  |
| 電線線徑        | Wire Size             | Leitergrößen        | 24~12AWG                    | 0.2~4mm <sup>2</sup> |
| 塑膠本體        | Housing Material      | Isolierstofftyp     | Polyamide66(UL94V-0)        |                      |
| 押線圈         | Cage Clamp            | Klemmkörper         | Brass, Ni plated            |                      |
| 導電夾片        | Contact               | Kontakt             | Phosphor bronze, Tin plated |                      |
| 螺絲          | Screw Size            | Schraubengewinde    | M2.6, steel, Ni plated      |                      |
| 操作溫度        | Operating Temperature | Umgebungstemperatur | -40°C to + 105°C            |                      |
| 扭力          | Torque                | Anzugsmoment        | 7.0 lb-inch                 |                      |
| UL File No. | E167040               |                     |                             |                      |

## TABLE

| Item No.   | A(mm) | A(inch) |
|------------|-------|---------|
| MC211-E102 | 20.0  | 0.787   |
| MC211-E103 | 25.0  | 0.984   |
| MC211-E104 | 30.0  | 1.181   |
| MC211-E105 | 35.0  | 1.378   |
| MC211-E106 | 40.0  | 1.575   |
| MC211-E107 | 45.0  | 1.772   |
| MC211-E108 | 50.0  | 1.969   |
| MC211-E109 | 55.0  | 2.165   |
| MC211-E110 | 60.0  | 2.362   |
| MC211-E111 | 65.0  | 2.559   |
| MC211-E112 | 70.0  | 2.755   |
| MC211-E113 | 75.0  | 2.952   |
| MC211-E114 | 80.0  | 3.149   |
| MC211-E115 | 85.0  | 3.346   |
| MC211-E116 | 90.0  | 3.543   |
| MC211-E117 | 95.0  | 3.740   |
| MC211-E118 | 100.0 | 3.937   |
| MC211-E119 | 105.0 | 4.133   |
| MC211-E120 | 110.0 | 4.331   |
| MC211-E121 | 115.0 | 4.527   |
| MC211-E122 | 120.0 | 4.724   |

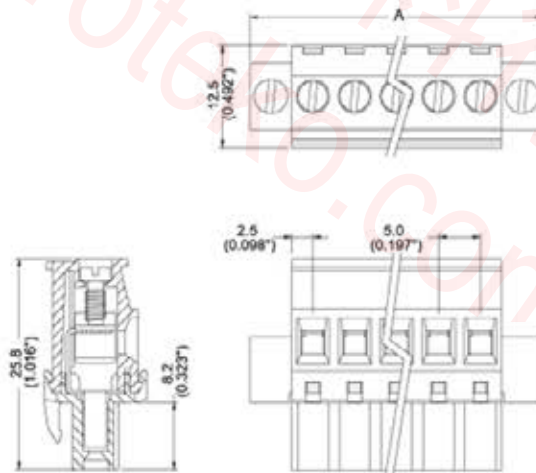

Note:  
Screw Plating: Changes are available upon request

# MC 211-F1

Pluggable terminal block with flanges



Pitch: 5.08mm(0.200inch)



## SPECIFICATIONS

|             |                       |                     | CUL                         | VDE                  |
|-------------|-----------------------|---------------------|-----------------------------|----------------------|
| 負載電壓        | Rated Voltage         | Bemessungsspannung  | AC 300V                     | AC 380V              |
| 負載電流        | Rated Current         | Bemessungsstrom     | 16A                         | 16A                  |
| 電線線徑        | Wire Size             | Leitergrößen        | 24~12AWG                    | 0.2~4mm <sup>2</sup> |
| 塑膠本體        | Housing Material      | Isolierstofftyp     | Polyamide66(UL94V-0)        |                      |
| 押線圈         | Cage Clamp            | Klemmkörper         | Brass, Ni plated            |                      |
| 導電夾片        | Contact               | Kontakt             | Phosphor bronze, Tin plated |                      |
| 螺絲          | Screw Size            | Schraubengewinde    | M2.6, steel, Ni plated      |                      |
| 操作溫度        | Operating Temperature | Umgebungstemperatur | -40°C to + 105°C            |                      |
| 扭力          | Torque                | Anzugsmoment        | 7.0 lb-inch                 |                      |
| UL File No. | E167040               |                     |                             |                      |

## TABLE

| Item No.   | A(mm) | A(inch) |
|------------|-------|---------|
| MC211-F102 | 20.3  | 0.800   |
| MC211-F103 | 25.4  | 1.000   |
| MC211-F104 | 30.5  | 1.200   |
| MC211-F105 | 35.6  | 1.400   |
| MC211-F106 | 40.6  | 1.600   |
| MC211-F107 | 45.7  | 1.800   |
| MC211-F108 | 50.8  | 2.000   |
| MC211-F109 | 55.9  | 2.200   |
| MC211-F110 | 61.0  | 2.400   |
| MC211-F111 | 66.0  | 2.600   |
| MC211-F112 | 71.1  | 2.800   |
| MC211-F113 | 76.2  | 3.000   |
| MC211-F114 | 81.3  | 3.200   |
| MC211-F115 | 86.4  | 3.400   |
| MC211-F116 | 91.4  | 3.600   |
| MC211-F117 | 96.5  | 3.800   |
| MC211-F118 | 101.6 | 4.000   |
| MC211-F119 | 106.7 | 4.200   |
| MC211-F120 | 111.8 | 4.400   |
| MC211-F121 | 116.8 | 4.600   |
| MC211-F122 | 121.9 | 4.800   |

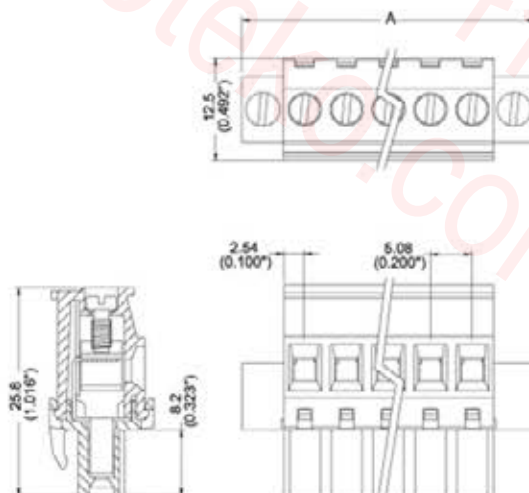

Note:  
Screw Plating: Changes are available upon request



# MC 230-E1 Pluggable terminal block with cover



Pitch: 5.00mm(0.197inch)



## SPECIFICATIONS

|             |                       |                     | CUL                         | VDE |
|-------------|-----------------------|---------------------|-----------------------------|-----|
| 負載電壓        | Rated Voltage         | Bemessungsspannung  | AC 300V                     |     |
| 負載電流        | Rated Current         | Bemessungsstrom     | 16A                         |     |
| 電線線徑        | Wire Size             | Leitergrößen        | 24~14AWG                    |     |
| 塑膠本體        | Housing Material      | Isolierstofftyp     | Polyamide66(UL94V-0)        |     |
| 押線圈         | Cage Clamp            | Klemmkörper         | Brass, Ni plated            |     |
| 導電夾片        | Contact               | Kontakt             | Phosphor bronze, Tin plated |     |
| 螺絲          | Screw Size            | Schraubengewinde    | M2.6, steel, Zinc plated    |     |
| 操作溫度        | Operating Temperature | Umgebungstemperatur | -40°C to + 105°C            |     |
| 扭力          | Torque                | Anzugsmoment        | 4.5 lb-inch                 |     |
| UL File No. | E167040               |                     |                             |     |

## TABLE

| Item No.   | A(mm) | A(inch) |
|------------|-------|---------|
| MC230-E102 | 10.0  | 0.394   |
| MC230-E103 | 15.0  | 0.591   |
| MC230-E104 | 20.0  | 0.787   |
| MC230-E105 | 25.0  | 0.984   |
| MC230-E106 | 30.0  | 1.181   |
| MC230-E107 | 35.0  | 1.378   |
| MC230-E108 | 40.0  | 1.575   |

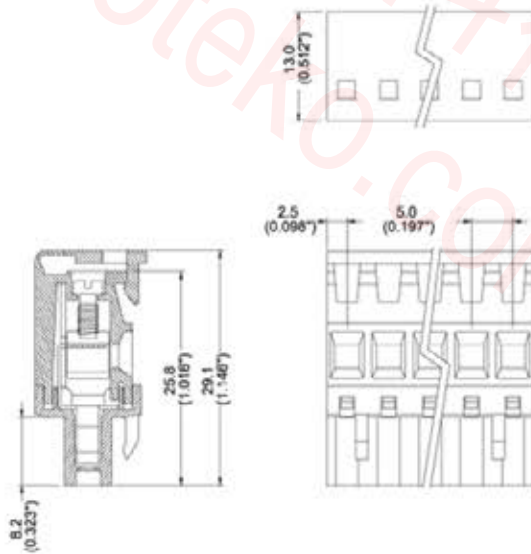

Note:  
Screw Plating: Changes are available upon request

# MC 230-F1

Pluggable terminal block with cover



Pitch: 5.08mm(0.200inch)



## SPECIFICATIONS

|             |                       |                     | CUL                         | VDE |
|-------------|-----------------------|---------------------|-----------------------------|-----|
| 負載電壓        | Rated Voltage         | Bemessungsspannung  | AC 300V                     |     |
| 負載電流        | Rated Current         | Bemessungsstrom     | 16A                         |     |
| 電線線徑        | Wire Size             | Leitergrößen        | 24~14AWG                    |     |
| 塑膠本體        | Housing Material      | Isolierstofftyp     | Polyamide66(UL94V-0)        |     |
| 押線圈         | Cage Clamp            | Klemmkörper         | Brass, Ni plated            |     |
| 導電夾片        | Contact               | Kontakt             | Phosphor bronze, Tin plated |     |
| 螺絲          | Screw Size            | Schraubengewinde    | M2.6, steel, Zinc plated    |     |
| 操作溫度        | Operating Temperature | Umgebungstemperatur | -40°C to + 105°C            |     |
| 扭力          | Torque                | Anzugsmoment        | 4.5 lb-inch                 |     |
| UL File No. | E167040               |                     |                             |     |

## TABLE

| Item No.   | A(mm) | A(inch) |
|------------|-------|---------|
| MC230-F102 | 10.2  | 0.400   |
| MC230-F103 | 15.2  | 0.600   |
| MC230-F104 | 20.3  | 0.800   |
| MC230-F105 | 25.4  | 1.000   |
| MC230-F106 | 30.5  | 1.200   |
| MC230-F107 | 35.6  | 1.400   |
| MC230-F108 | 40.6  | 1.600   |

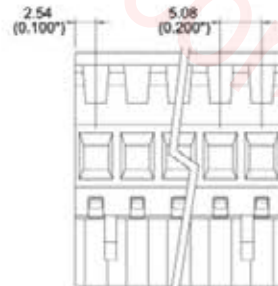
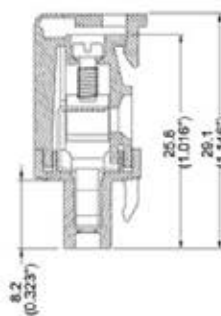

Note:  
Screw Plating: Changes are available upon request

Pitch: 5.00mm(0.197inch)

- **Description :**
- Pitch : 5.00 mm (0.197 inch)

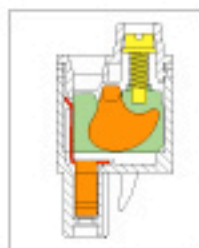

## SPECIFICATIONS

|             |                       |                     | CUL                         | VDE                  |
|-------------|-----------------------|---------------------|-----------------------------|----------------------|
| 負載電壓        | Rated Voltage         | Bemessungsspannung  | AC 300V                     | AC 250V              |
| 負載電流        | Rated Current         | Bemessungsstrom     | 16A                         | 16A                  |
| 電線線徑        | Wire Size             | Leitergrößen        | 24~14AWG                    | 0.2~4mm <sup>2</sup> |
| 塑膠本體        | Housing Material      | Isolierstofftyp     | Polyamide66(UL94V-0)        |                      |
| 押線圈         | Cage Clamp            | Klemmkörper         | Steel, Zinc plated          |                      |
| 導電夾片        | Contact               | Kontakt             | Phosphor bronze, Tin plated |                      |
| 螺絲          | Screw Size            | Schraubengewinde    | M2.6, steel, Zinc plated    |                      |
| 操作溫度        | Operating Temperature | Umgebungstemperatur | -40°C to + 105°C            |                      |
| 扭力          | Torque                | Anzugsmoment        | 7.0 lb-inch                 |                      |
| UL File No. | E167040               |                     |                             |                      |

TABLE

| Item No.    | A(mm) | A(inch) |
|-------------|-------|---------|
| MC310#50002 | 10.0  | 0.394   |
| MC310#50003 | 15.0  | 0.591   |
| MC310#50004 | 20.0  | 0.787   |
| MC310#50005 | 25.0  | 0.984   |
| MC310#50006 | 30.0  | 1.181   |
| MC310#50007 | 35.0  | 1.378   |
| MC310#50008 | 40.0  | 1.575   |
| MC310#50009 | 45.0  | 1.772   |
| MC310#50010 | 50.0  | 1.969   |
| MC310#50011 | 55.0  | 2.165   |
| MC310#50012 | 60.0  | 2.362   |
| MC310#50013 | 65.0  | 2.559   |
| MC310#50014 | 70.0  | 2.756   |
| MC310#50015 | 75.0  | 2.953   |
| MC310#50016 | 80.0  | 3.150   |
| MC310#50017 | 85.0  | 3.346   |
| MC310#50018 | 90.0  | 3.543   |
| MC310#50019 | 95.0  | 3.740   |
| MC310#50020 | 100.0 | 3.937   |
| MC310#50021 | 105.0 | 4.134   |
| MC310#50022 | 110.0 | 4.331   |
| MC310#50023 | 115.0 | 4.528   |
| MC310#50024 | 120.0 | 4.724   |

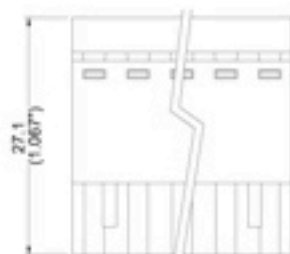
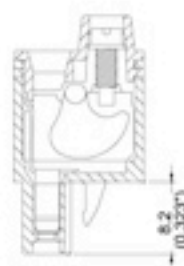
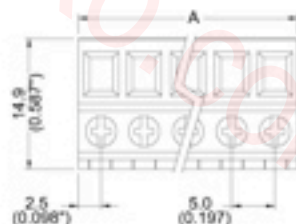

Note:  
Screw Plating: Changes are available upon request

Pitch: 5.08mm(0.200inch)

- **Description :**
- Pitch : 5.08 mm (0.200 inch)

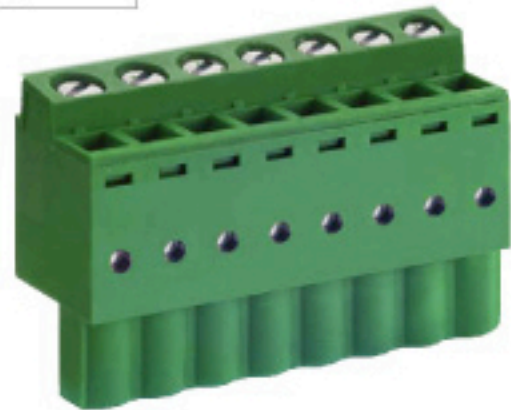
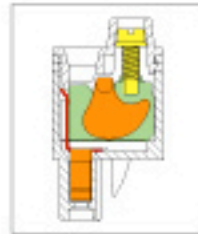

## SPECIFICATIONS

|      |                       |                     | CUL                         | VDE                  |
|------|-----------------------|---------------------|-----------------------------|----------------------|
| 負載電壓 | Rated Voltage         | Bemessungsspannung  | AC 300V                     | AC 250V              |
| 負載電流 | Rated Current         | Bemessungsstrom     | 16A                         | 16A                  |
| 電線線徑 | Wire Size             | Leitergrößen        | 24~14AWG                    | 0.2~4mm <sup>2</sup> |
| 塑膠本體 | Housing Material      | Isolierstofftyp     | Polyamide66(UL94V-0)        |                      |
| 押線圈  | Cage Clamp            | Klemmkörper         | Steel, Zinc plated          |                      |
| 導電夾片 | Contact               | Kontakt             | Phosphor bronze, Tin plated |                      |
| 螺絲   | Screw Size            | Schraubengewinde    | M2.6, steel, Zinc plated    |                      |
| 操作溫度 | Operating Temperature | Umgebungstemperatur | -40°C to + 105°C            |                      |
| 扭力   | Torque                | Anzugsmoment        | 7.0 lb-inch                 |                      |

UL File No. E167040

TABLE

| Item No.    | A(mm) | A(inch) |
|-------------|-------|---------|
| MC310#50802 | 10.2  | 0.400   |
| MC310#50803 | 15.2  | 0.600   |
| MC310#50804 | 20.3  | 0.800   |
| MC310#50805 | 25.4  | 1.000   |
| MC310#50806 | 30.5  | 1.200   |
| MC310#50807 | 35.6  | 1.400   |
| MC310#50808 | 40.6  | 1.600   |
| MC310#50809 | 45.7  | 1.800   |
| MC310#50810 | 50.8  | 2.000   |
| MC310#50811 | 55.9  | 2.200   |
| MC310#50812 | 61.0  | 2.400   |
| MC310#50813 | 66.0  | 2.600   |
| MC310#50814 | 71.1  | 2.800   |
| MC310#50815 | 76.2  | 3.000   |
| MC310#50816 | 81.3  | 3.200   |
| MC310#50817 | 86.4  | 3.400   |
| MC310#50818 | 91.4  | 3.600   |
| MC310#50819 | 96.5  | 3.800   |
| MC310#50820 | 101.6 | 4.000   |
| MC310#50821 | 106.7 | 4.200   |
| MC310#50822 | 111.8 | 4.400   |
| MC310#50823 | 116.8 | 4.600   |
| MC310#50824 | 121.9 | 4.800   |

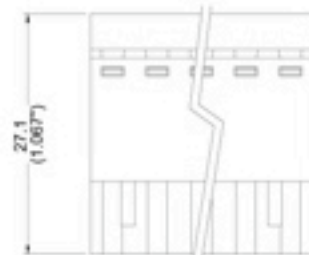
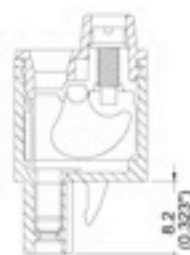
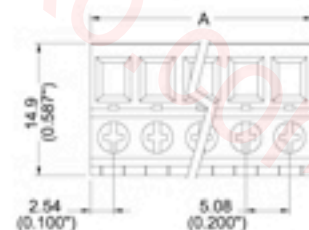

Note:

Screw Plating: Changes are available upon request

Pitch: 5.00mm(0.197inch)

- **Description:**
- Pitch : 5.00mm (0.197inch)

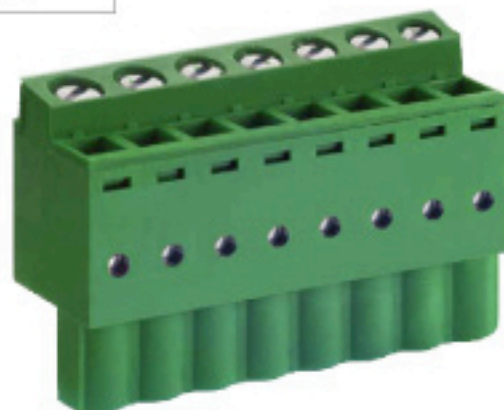
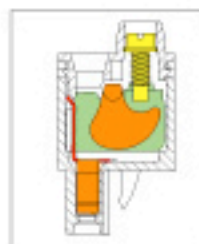

## SPECIFICATIONS

|             |                       |                     | CUL                         | VDE                  |
|-------------|-----------------------|---------------------|-----------------------------|----------------------|
| 負載電壓        | Rated Voltage         | Bemessungsspannung  | AC 300V                     | AC 250V              |
| 負載電流        | Rated Current         | Bemessungsstrom     | 16A                         | 16A                  |
| 電線線徑        | Wire Size             | Leitergrößen        | 24~14AWG                    | 0.2~4mm <sup>2</sup> |
| 塑膠本體        | Housing Material      | Isolierstofftyp     | Polyamide66(UL94V-0)        |                      |
| 押線圈         | Cage Clamp            | Klemmkörper         | Steel, Zinc plated          |                      |
| 導電夾片        | Contact               | Kontakt             | Phosphor bronze, Tin plated |                      |
| 螺絲          | Screw Size            | Schraubengewinde    | M2.6, steel, Zinc plated    |                      |
| 操作溫度        | Operating Temperature | Umgebungstemperatur | -40°C to + 105°C            |                      |
| 扭力          | Torque                | Anzugsmoment        | 7.0 lb-inch                 |                      |
| UL File No. | E167040               |                     |                             |                      |

TABLE

| Item No.    | A(mm) | A(inch) |
|-------------|-------|---------|
| MC310#50002 | 10.0  | 0.394   |
| MC310#50003 | 15.0  | 0.591   |
| MC310#50004 | 20.0  | 0.787   |
| MC310#50005 | 25.0  | 0.984   |
| MC310#50006 | 30.0  | 1.181   |
| MC310#50007 | 35.0  | 1.378   |
| MC310#50008 | 40.0  | 1.575   |
| MC310#50009 | 45.0  | 1.772   |
| MC310#50010 | 50.0  | 1.969   |
| MC310#50011 | 55.0  | 2.165   |
| MC310#50012 | 60.0  | 2.362   |
| MC310#50013 | 65.0  | 2.559   |
| MC310#50014 | 70.0  | 2.756   |
| MC310#50015 | 75.0  | 2.953   |
| MC310#50016 | 80.0  | 3.150   |
| MC310#50017 | 85.0  | 3.346   |
| MC310#50018 | 90.0  | 3.543   |
| MC310#50019 | 95.0  | 3.740   |
| MC310#50020 | 100.0 | 3.937   |
| MC310#50021 | 105.0 | 4.134   |
| MC310#50022 | 110.0 | 4.331   |
| MC310#50023 | 115.0 | 4.528   |
| MC310#50024 | 120.0 | 4.724   |

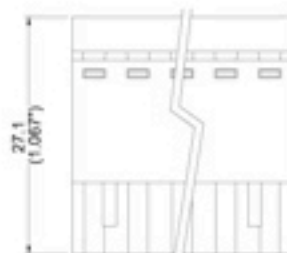
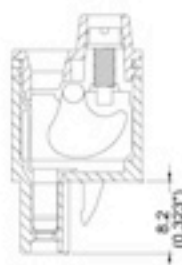
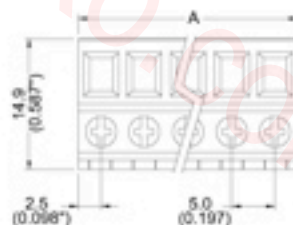

Note:  
Screw Plating: Changes are available upon request

Pitch: 5.08mm(0.200inch)

- **Description:**
- Pitch : 5.08mm (0.200inch)

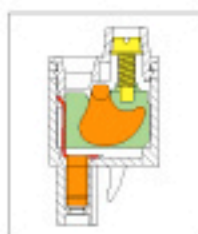

## SPECIFICATIONS

|      |                       |                     | CUL                         | VDE                  |
|------|-----------------------|---------------------|-----------------------------|----------------------|
| 負載電壓 | Rated Voltage         | Bemessungsspannung  | AC 300V                     | AC 250V              |
| 負載電流 | Rated Current         | Bemessungsstrom     | 16A                         | 16A                  |
| 電線線徑 | Wire Size             | Leitergrößen        | 24~14AWG                    | 0.2~4mm <sup>2</sup> |
| 塑膠本體 | Housing Material      | Isolierstofftyp     | Polyamide66(UL94V-0)        |                      |
| 押線圈  | Cage Clamp            | Klemmkörper         | Steel, Zinc plated          |                      |
| 導電夾片 | Contact               | Kontakt             | Phosphor bronze, Tin plated |                      |
| 螺絲   | Screw Size            | Schraubengewinde    | M2.6, steel, Zinc plated    |                      |
| 操作溫度 | Operating Temperature | Umgebungstemperatur | -40°C to + 105°C            |                      |
| 扭力   | Torque                | Anzugsmoment        | 7.0 lb-inch                 |                      |

UL File No. E167040

## TABLE

| Item No.    | A(mm) | A(inch) |
|-------------|-------|---------|
| MC310#50802 | 10.2  | 0.400   |
| MC310#50803 | 15.2  | 0.600   |
| MC310#50804 | 20.3  | 0.800   |
| MC310#50805 | 25.4  | 1.000   |
| MC310#50806 | 30.5  | 1.200   |
| MC310#50807 | 35.6  | 1.400   |
| MC310#50808 | 40.6  | 1.600   |
| MC310#50809 | 45.7  | 1.800   |
| MC310#50810 | 50.8  | 2.000   |
| MC310#50811 | 55.9  | 2.200   |
| MC310#50812 | 61.0  | 2.400   |
| MC310#50813 | 66.0  | 2.600   |
| MC310#50814 | 71.1  | 2.800   |
| MC310#50815 | 76.2  | 3.000   |
| MC310#50816 | 81.3  | 3.200   |
| MC310#50817 | 86.4  | 3.400   |
| MC310#50818 | 91.4  | 3.600   |
| MC310#50819 | 96.5  | 3.800   |
| MC310#50820 | 101.6 | 4.000   |
| MC310#50821 | 106.7 | 4.200   |
| MC310#50822 | 111.8 | 4.400   |
| MC310#50823 | 116.8 | 4.600   |
| MC310#50824 | 121.9 | 4.800   |

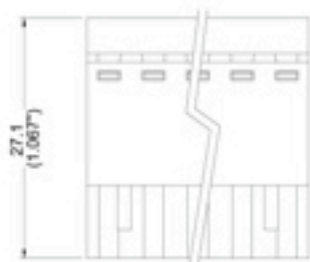
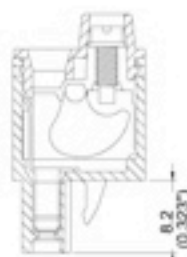
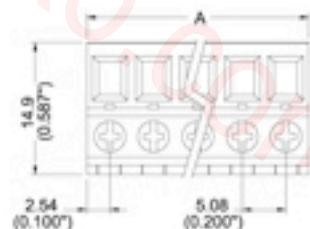

Note:

Screw Plating: Changes are available upon request

Pitch: 5.00mm(0.197inch)

- Description :
- Pitch : 5.00 mm (0.197 inch)

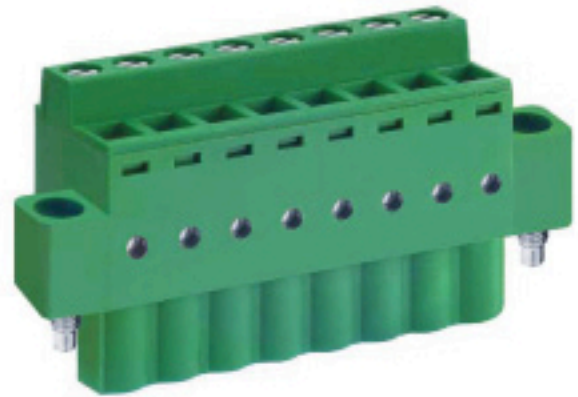
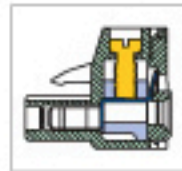

## SPECIFICATIONS

|      |                       |                     | CUL                         | VDE                  |
|------|-----------------------|---------------------|-----------------------------|----------------------|
| 負載電壓 | Rated Voltage         | Bemessungsspannung  | AC 300V                     | AC 250V              |
| 負載電流 | Rated Current         | Bemessungsstrom     | 16A                         | 16A                  |
| 電線線徑 | Wire Size             | Leitergrößen        | 24~14AWG                    | 0.2~4mm <sup>2</sup> |
| 塑膠本體 | Housing Material      | Isolierstofftyp     | Polyamide66(UL94V-0)        |                      |
| 押線圈  | Cage Clamp            | Klemmkörper         | Brass, Ni plated            |                      |
| 導電夾片 | Contact               | Kontakt             | Phosphor bronze, Tin plated |                      |
| 螺絲   | Screw Size            | Schraubengewinde    | M2.6, steel, Zinc plated    |                      |
| 操作溫度 | Operating Temperature | Umgebungstemperatur | -40°C to + 105°C            |                      |
| 扭力   | Torque                | Anzugsmoment        | 7.0 lb-inch                 |                      |

UL File No. E167040

## TABLE

| Item No.    | A(mm) | A(inch) |
|-------------|-------|---------|
| MC311#50002 | 20.0  | 0.787   |
| MC311#50003 | 25.0  | 0.984   |
| MC311#50004 | 30.0  | 1.181   |
| MC311#50005 | 35.0  | 1.378   |
| MC311#50006 | 40.0  | 1.575   |
| MC311#50007 | 45.0  | 1.772   |
| MC311#50008 | 50.0  | 1.969   |
| MC311#50009 | 55.0  | 2.165   |
| MC311#50010 | 60.0  | 2.362   |
| MC311#50011 | 65.0  | 2.559   |
| MC311#50012 | 70.0  | 2.756   |
| MC311#50013 | 75.0  | 2.953   |
| MC311#50014 | 80.0  | 3.150   |
| MC311#50015 | 85.0  | 3.346   |
| MC311#50016 | 90.0  | 3.543   |
| MC311#50017 | 95.0  | 3.740   |
| MC311#50018 | 100.0 | 3.937   |
| MC311#50019 | 105.0 | 4.134   |
| MC311#50020 | 110.0 | 4.331   |
| MC311#50021 | 115.0 | 4.528   |
| MC311#50022 | 120.0 | 4.724   |
| MC311#50023 | 125.0 | 4.922   |
| MC311#50024 | 130.0 | 5.118   |

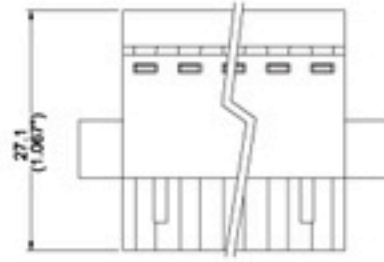
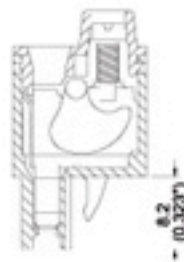
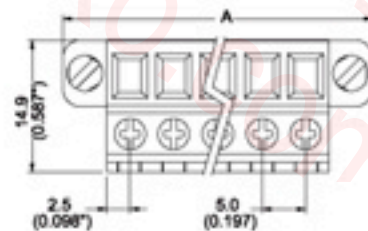

Note:

Screw Plating: Changes are available upon request

# MC 311#500 Pluggable terminal block with flanges **DECA**

Front wire entry/Front actuation

Pitch: 5.00mm(0.197inch)



## SPECIFICATIONS

|             |                       |                     | CUL                         | VDE                  |
|-------------|-----------------------|---------------------|-----------------------------|----------------------|
| 負載電壓        | Rated Voltage         | Bemessungsspannung  | AC 300V                     | AC 250V              |
| 負載電流        | Rated Current         | Bemessungsstrom     | 16A                         | 16A                  |
| 電線線徑        | Wire Size             | Leitergrößen        | 24~14AWG                    | 0.2~4mm <sup>2</sup> |
| 塑膠本體        | Housing Material      | Isolierstofftyp     | Polyamide66(UL94V-0)        |                      |
| 押線圈         | Cage Clamp            | Klemmkörper         | Steel, Zinc plated          |                      |
| 導電夾片        | Contact               | Kontakt             | Phosphor bronze, Tin plated |                      |
| 螺絲          | Screw Size            | Schraubengewinde    | M2.6, steel, Zinc plated    |                      |
| 操作溫度        | Operating Temperature | Umgebungstemperatur | -40°C to + 105°C            |                      |
| 扭力          | Torque                | Anzugsmoment        | 7.0 lb-inch                 |                      |
| UL File No. | E167040               |                     |                             |                      |

## TABLE

| Item No.    | A(mm) | A(inch) |
|-------------|-------|---------|
| MC311#50002 | 20.0  | 0.787   |
| MC311#50003 | 25.0  | 0.984   |
| MC311#50004 | 30.0  | 1.181   |
| MC311#50005 | 35.0  | 1.378   |
| MC311#50006 | 40.0  | 1.575   |
| MC311#50007 | 45.0  | 1.772   |
| MC311#50008 | 50.0  | 1.969   |
| MC311#50009 | 55.0  | 2.165   |
| MC311#50010 | 60.0  | 2.362   |
| MC311#50011 | 65.0  | 2.559   |
| MC311#50012 | 70.0  | 2.756   |
| MC311#50013 | 75.0  | 2.953   |
| MC311#50014 | 80.0  | 3.150   |
| MC311#50015 | 85.0  | 3.346   |
| MC311#50016 | 90.0  | 3.543   |
| MC311#50017 | 95.0  | 3.740   |
| MC311#50018 | 100.0 | 3.937   |
| MC311#50019 | 105.0 | 4.134   |
| MC311#50020 | 110.0 | 4.331   |
| MC311#50021 | 115.0 | 4.528   |
| MC311#50022 | 120.0 | 4.724   |
| MC311#50023 | 125.0 | 4.922   |
| MC311#50024 | 130.0 | 5.118   |

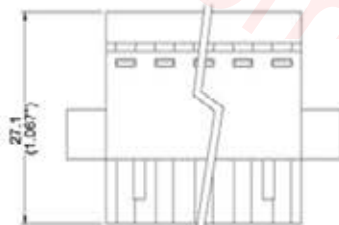
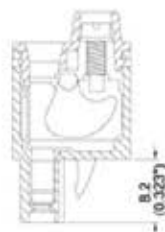
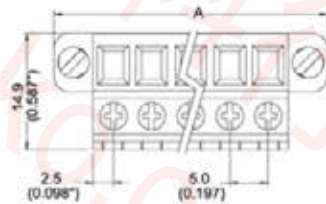

Note:  
Screw Plating: Changes are available upon request



Pitch: 5.08mm(0.200inch)

- **Description:**
- Pitch : 5.08mm (0.200inch)

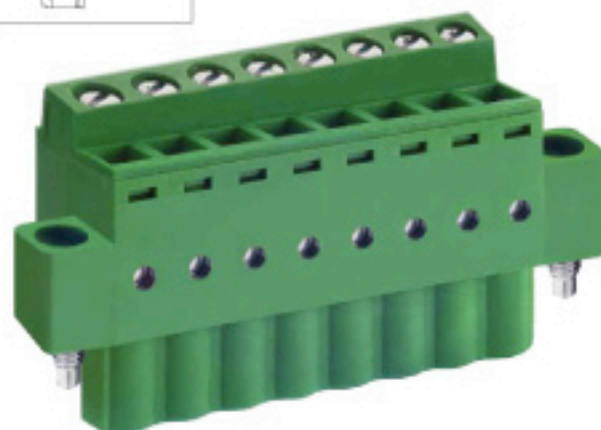
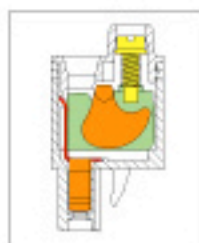

## SPECIFICATIONS

|             |                       |                     | CUL                         | VDE                  |
|-------------|-----------------------|---------------------|-----------------------------|----------------------|
| 負載電壓        | Rated Voltage         | Bemessungsspannung  | AC 300V                     | AC 250V              |
| 負載電流        | Rated Current         | Bemessungsstrom     | 16A                         | 16A                  |
| 電線線徑        | Wire Size             | Leitergrößen        | 24~14AWG                    | 0.2~4mm <sup>2</sup> |
| 塑膠本體        | Housing Material      | Isolierstofftyp     | Polyamide66(UL94V-0)        |                      |
| 押線圈         | Cage Clamp            | Klemmkörper         | Steel, Zinc plated          |                      |
| 導電夾片        | Contact               | Kontakt             | Phosphor bronze, Tin plated |                      |
| 螺絲          | Screw Size            | Schraubengewinde    | M2.6, steel, Zinc plated    |                      |
| 操作溫度        | Operating Temperature | Umgebungstemperatur | -40°C to + 105°C            |                      |
| 扭力          | Torque                | Anzugsmoment        | 7.0 lb-inch                 |                      |
| UL File No. | E167040               |                     |                             |                      |

TABLE

| Item No.    | A(mm) | A(inch) |
|-------------|-------|---------|
| MC311#50802 | 20.3  | 0.800   |
| MC311#50803 | 25.4  | 1.000   |
| MC311#50804 | 30.5  | 1.200   |
| MC311#50805 | 35.6  | 1.400   |
| MC311#50806 | 40.6  | 1.600   |
| MC311#50807 | 45.7  | 1.800   |
| MC311#50808 | 50.8  | 2.000   |
| MC311#50809 | 55.9  | 2.200   |
| MC311#50810 | 61.0  | 2.400   |
| MC311#50811 | 66.0  | 2.600   |
| MC311#50812 | 71.1  | 2.800   |
| MC311#50813 | 76.2  | 3.000   |
| MC311#50814 | 81.3  | 3.200   |
| MC311#50815 | 86.4  | 3.400   |
| MC311#50816 | 91.4  | 3.600   |
| MC311#50817 | 96.5  | 3.800   |
| MC311#50818 | 101.6 | 4.000   |
| MC311#50819 | 106.7 | 4.200   |
| MC311#50820 | 111.8 | 4.400   |
| MC311#50821 | 116.8 | 4.600   |
| MC311#50822 | 121.9 | 4.800   |
| MC311#50823 | 127.0 | 5.000   |
| MC311#50824 | 132.0 | 5.200   |

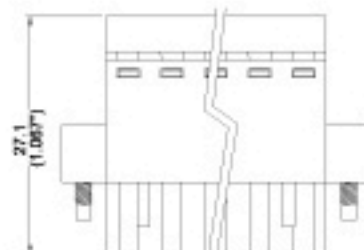
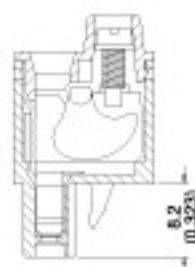
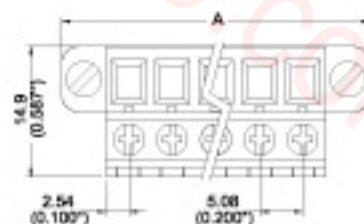

Note:

Screw Plating: Changes are available upon request

# MC 420-350 Pluggable terminal block



Pitch: 3.50mm(0.138inch)



## SPECIFICATIONS

|             |                       |                     | CUL                         | VDE                    |
|-------------|-----------------------|---------------------|-----------------------------|------------------------|
| 負載電壓        | Rated Voltage         | Bemessungsspannung  | AC 300V                     | AC 300V                |
| 負載電流        | Rated Current         | Bemessungsstrom     | 10A                         | 10A                    |
| 電線線徑        | Wire Size             | Leitergrößen        | 26~16AWG                    | 0.2~1.5mm <sup>2</sup> |
| 塑膠本體        | Housing Material      | Isolierstofftyp     | Polyamide66(UL94V-0)        |                        |
| 押線圈         | Cage Clamp            | Klemmkörper         | Brass, Ni plated            |                        |
| 導電夾片        | Contact               | Kontakt             | Phosphor bronze, Tin plated |                        |
| 螺絲          | Screw Size            | Schraubengewinde    | M2.0, steel, Ni plated      |                        |
| 操作溫度        | Operating Temperature | Umgebungstemperatur | -40°C to + 105°C            |                        |
| 扭力          | Torque                | Anzugsmoment        | 3.0 lb-inch                 |                        |
| UL File No. | E167040               |                     |                             |                        |

## TABLE

| Item No.    | A(mm) | A(inch) |
|-------------|-------|---------|
| MC420-35002 | 7.8   | 0.307   |
| MC420-35003 | 11.3  | 0.445   |
| MC420-35004 | 14.8  | 0.583   |
| MC420-35005 | 18.3  | 0.720   |
| MC420-35006 | 21.8  | 0.858   |
| MC420-35007 | 25.3  | 0.996   |
| MC420-35008 | 28.8  | 1.134   |
| MC420-35009 | 32.3  | 1.272   |
| MC420-35010 | 35.8  | 1.409   |
| MC420-35011 | 39.3  | 1.547   |
| MC420-35012 | 42.8  | 1.685   |
| MC420-35013 | 46.3  | 1.823   |
| MC420-35014 | 49.8  | 1.961   |
| MC420-35015 | 53.3  | 2.098   |
| MC420-35016 | 56.8  | 2.236   |
| MC420-35017 | 60.3  | 2.374   |
| MC420-35018 | 63.8  | 2.512   |
| MC420-35019 | 67.3  | 2.650   |
| MC420-35020 | 70.8  | 2.787   |
| MC420-35021 | 74.3  | 2.925   |
| MC420-35022 | 77.8  | 3.063   |
| MC420-35023 | 81.3  | 3.201   |
| MC420-35024 | 84.8  | 3.339   |

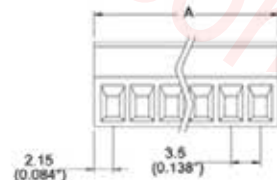
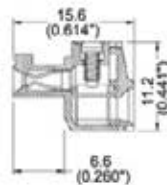
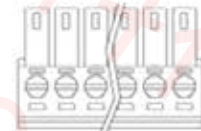

Note:  
Screw Plating: Changes are available upon request

# MC 420-381 Pluggable terminal block



Pitch: 3.81mm(0.150inch)



## SPECIFICATIONS

|             |                       |                     | CUL                         | VDE                    |
|-------------|-----------------------|---------------------|-----------------------------|------------------------|
| 負載電壓        | Rated Voltage         | Bemessungsspannung  | AC 300V                     | AC 300V                |
| 負載電流        | Rated Current         | Bemessungsstrom     | 10A                         | 10A                    |
| 電線線徑        | Wire Size             | Leitergrößen        | 26~16AWG                    | 0.2~1.5mm <sup>2</sup> |
| 塑膠本體        | Housing Material      | Isolierstofftyp     | Polyamide66(UL94V-0)        |                        |
| 押線圈         | Cage Clamp            | Klemmkörper         | Brass, Ni plated            |                        |
| 導電夾片        | Contact               | Kontakt             | Phosphor bronze, Tin plated |                        |
| 螺絲          | Screw Size            | Schraubengewinde    | M2.0, steel, Ni plated      |                        |
| 操作溫度        | Operating Temperature | Umgebungstemperatur | -40°C to + 105°C            |                        |
| 扭力          | Torque                | Anzugsmoment        | 3.0 lb-inch                 |                        |
| UL File No. | E167040               |                     |                             |                        |

## TABLE

| Item No.    | A(mm) | A(inch) |
|-------------|-------|---------|
| MC420-38102 | 8.4   | 0.331   |
| MC420-38103 | 12.2  | 0.481   |
| MC420-38104 | 16.0  | 0.631   |
| MC420-38105 | 19.9  | 0.781   |
| MC420-38106 | 23.7  | 0.931   |
| MC420-38107 | 27.5  | 1.081   |
| MC420-38108 | 31.3  | 1.231   |
| MC420-38109 | 35.1  | 1.381   |
| MC420-38110 | 38.9  | 1.531   |
| MC420-38111 | 42.7  | 1.681   |
| MC420-38112 | 46.5  | 1.831   |
| MC420-38113 | 50.3  | 1.981   |
| MC420-38114 | 54.1  | 2.131   |
| MC420-38115 | 58.0  | 2.281   |
| MC420-38116 | 61.8  | 2.431   |
| MC420-38117 | 65.6  | 2.581   |
| MC420-38118 | 69.4  | 2.731   |
| MC420-38119 | 73.2  | 2.881   |
| MC420-38120 | 77.0  | 3.031   |
| MC420-38121 | 80.8  | 3.181   |
| MC420-38122 | 84.6  | 3.331   |
| MC420-38123 | 88.4  | 3.481   |
| MC420-38124 | 92.2  | 3.631   |

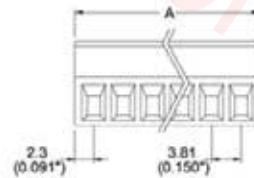
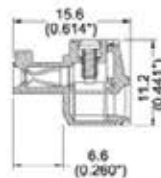

Note:  
Screw Plating: Changes are available upon request

# MC 421-350 Pluggable terminal block with flanges **DECA**

Pitch: 3.50mm(0.138inch)



## SPECIFICATIONS

|             |                       |                     | CUL                         | VDE                    |
|-------------|-----------------------|---------------------|-----------------------------|------------------------|
| 負載電壓        | Rated Voltage         | Bemessungsspannung  | AC 300V                     | AC 300V                |
| 負載電流        | Rated Current         | Bemessungsstrom     | 10A                         | 10A                    |
| 電線線徑        | Wire Size             | Leitergrößen        | 26~16AWG                    | 0.2~1.5mm <sup>2</sup> |
| 塑膠本體        | Housing Material      | Isolierstofftyp     | Polyamide66(UL94V-0)        |                        |
| 押線圈         | Cage Clamp            | Klemmkörper         | Brass, Ni plated            |                        |
| 導電夾片        | Contact               | Kontakt             | Phosphor bronze, Tin plated |                        |
| 螺絲          | Screw Size            | Schraubengewinde    | M2.0, steel, Ni plated      |                        |
| 操作溫度        | Operating Temperature | Umgebungstemperatur | -40°C to + 105°C            |                        |
| 扭力          | Torque                | Anzugsmoment        | 3.0 lb-inch                 |                        |
| UL File No. | E167040               |                     |                             |                        |

TABLE

| Item No.    | A(mm) | A(inch) |
|-------------|-------|---------|
| MC421-35002 | 17.4  | 0.685   |
| MC421-35003 | 20.9  | 0.823   |
| MC421-35004 | 24.4  | 0.961   |
| MC421-35005 | 27.9  | 1.098   |
| MC421-35006 | 31.4  | 1.236   |
| MC421-35007 | 34.9  | 1.374   |
| MC421-35008 | 38.4  | 1.512   |
| MC421-35009 | 41.9  | 1.650   |
| MC421-35010 | 45.4  | 1.787   |
| MC421-35011 | 48.9  | 1.925   |
| MC421-35012 | 52.4  | 2.063   |
| MC421-35013 | 55.9  | 2.201   |
| MC421-35014 | 59.4  | 2.339   |
| MC421-35015 | 62.9  | 2.476   |
| MC421-35016 | 66.4  | 2.614   |
| MC421-35017 | 69.9  | 2.752   |
| MC421-35018 | 73.4  | 2.890   |
| MC421-35019 | 76.9  | 3.028   |
| MC421-35020 | 80.4  | 3.165   |
| MC421-35021 | 83.9  | 3.303   |
| MC421-35022 | 87.4  | 3.441   |
| MC421-35023 | 90.9  | 3.579   |
| MC421-35024 | 94.4  | 3.717   |

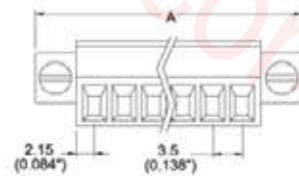
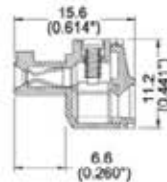

Note:  
Screw Plating: Changes are available upon request

# MC 421-381 Pluggable terminal block with flanges **DECA**

TERMINAL BLOCKS

C-31

Pitch: 3.81mm(0.150inch)



## SPECIFICATIONS

|             |                       |                     | CUL                         | VDE                    |
|-------------|-----------------------|---------------------|-----------------------------|------------------------|
| 負載電壓        | Rated Voltage         | Bemessungsspannung  | AC 300V                     | AC 300V                |
| 負載電流        | Rated Current         | Bemessungsstrom     | 10A                         | 10A                    |
| 電線線徑        | Wire Size             | Leitergrößen        | 26~16AWG                    | 0.2~1.5mm <sup>2</sup> |
| 塑膠本體        | Housing Material      | Isolierstofftyp     | Polyamide66(UL94V-0)        |                        |
| 押線圈         | Cage Clamp            | Klemmkörper         | Brass, Ni plated            |                        |
| 導電夾片        | Contact               | Kontakt             | Phosphor bronze, Tin plated |                        |
| 螺絲          | Screw Size            | Schraubengewinde    | M2.0, steel, Ni plated      |                        |
| 操作溫度        | Operating Temperature | Umgebungstemperatur | -40°C to + 105°C            |                        |
| 扭力          | Torque                | Anzugsmoment        | 3.0 lb-inch                 |                        |
| UL File No. | E167040               |                     |                             |                        |

## TABLE

| Item No.    | A(mm) | A(inch) |
|-------------|-------|---------|
| MC421-38102 | 17.9  | 0.705   |
| MC421-38103 | 21.7  | 0.855   |
| MC421-38104 | 25.5  | 1.005   |
| MC421-38105 | 29.3  | 1.155   |
| MC421-38106 | 33.1  | 1.305   |
| MC421-38107 | 37.0  | 1.455   |
| MC421-38108 | 40.8  | 1.605   |
| MC421-38109 | 44.6  | 1.755   |
| MC421-38110 | 48.4  | 1.905   |
| MC421-38111 | 52.2  | 2.055   |
| MC421-38112 | 56.0  | 2.205   |
| MC421-38113 | 59.8  | 2.355   |
| MC421-38114 | 63.6  | 2.505   |
| MC421-38115 | 67.4  | 2.655   |
| MC421-38116 | 71.2  | 2.805   |
| MC421-38117 | 75.1  | 2.955   |
| MC421-38118 | 78.9  | 3.105   |
| MC421-38119 | 82.7  | 3.255   |
| MC421-38120 | 86.5  | 3.405   |
| MC421-38121 | 90.3  | 3.555   |
| MC421-38122 | 94.1  | 3.705   |
| MC421-38123 | 97.9  | 3.855   |
| MC421-38124 | 101.7 | 4.005   |

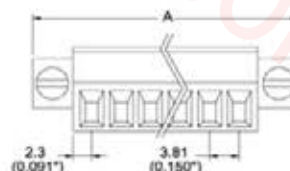
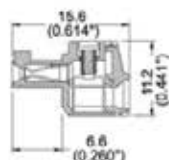

Note:  
Screw Plating: Changes are available upon request

# MC 520-350 Pluggable terminal block



Pitch: 3.50mm(0.138inch)



## SPECIFICATIONS

|      |                       |                     | CUL                         | VDE                    |
|------|-----------------------|---------------------|-----------------------------|------------------------|
| 負載電壓 | Rated Voltage         | Bemessungsspannung  |                             |                        |
| 負載電流 | Rated Current         | Bemessungsstrom     |                             |                        |
| 電線線徑 | Wire Size             | Leitergrößen        | 24~16AWG                    | 0.2~1.5mm <sup>2</sup> |
| 塑膠本體 | Housing Material      | Isolierstofftyp     | Polyamide66(UL94V-0)        |                        |
| 押線圈  | Cage Clamp            | Klemmkörper         | Brass, Ni plated            |                        |
| 導電夾片 | Contact               | Kontakt             | Phosphor bronze, Tin plated |                        |
| 螺絲   | Screw Size            | Schraubengewinde    | M2.0, steel, Ni plated      |                        |
| 操作溫度 | Operating Temperature | Umgebungstemperatur | -40°C to +105°C             |                        |
| 扭力   | Torque                | Anzugsmoment        | 3.0 lb-inch                 |                        |

TABLE

| Item No.    | A(mm) | A(inch) |
|-------------|-------|---------|
| MC520-35002 | 7.8   | 0.307   |
| MC520-35003 | 11.3  | 0.445   |
| MC520-35004 | 14.8  | 0.583   |
| MC520-35005 | 18.3  | 0.720   |
| MC520-35006 | 21.8  | 0.858   |
| MC520-35007 | 25.3  | 0.996   |
| MC520-35008 | 28.8  | 1.134   |
| MC520-35009 | 32.3  | 1.272   |
| MC520-35010 | 35.8  | 1.409   |
| MC520-35011 | 39.3  | 1.547   |
| MC520-35012 | 42.8  | 1.685   |
| MC520-35013 | 46.3  | 1.823   |
| MC520-35014 | 49.8  | 1.961   |
| MC520-35015 | 53.3  | 2.098   |
| MC520-35016 | 56.8  | 2.236   |
| MC520-35017 | 60.3  | 2.374   |
| MC520-35018 | 63.8  | 2.512   |
| MC520-35019 | 67.3  | 2.650   |
| MC520-35020 | 70.8  | 2.787   |
| MC520-35021 | 74.3  | 2.925   |
| MC520-35022 | 77.8  | 3.063   |
| MC520-35023 | 81.3  | 3.201   |
| MC520-35024 | 84.8  | 3.339   |

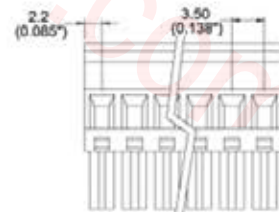
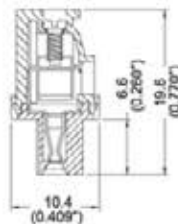

Note:  
Screw Plating: Changes are available upon request