

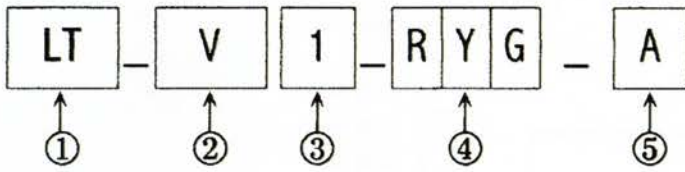

# Φ57mm Signal Tower Light

型號說明 Model Designation :



LTF : 閃爍式 Flashing Type

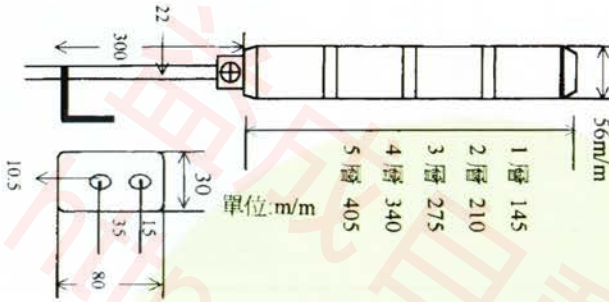

Φ 57 mm 多層式信號燈

項次 Item	代號 Model No.	說明 Description	項次 Item	代號 Model No.	說明 Description			
1. 型式 Type	LT	點燈式 Light-on Type	3. 層數 Layer	1	1 層 1 Layer			
	LTF	閃爍式 Flashing Type		2	2 層 2 Layers			
	ALT	點燈式附警報器 Light-on Type with Buzzer		3	3 層 3 Layers			
	ALTF	閃爍式附警報器 Flashing Type with Buzzer		4	4 層 4 Layers			
	DLT	點燈式 Light-on Type (LED)		5	5 層 5 Layers			
	DLTF	閃爍式 Flashing Type (LED)	4. 顏色 Color	R	紅 Red			
	ADLT	點燈式附警報器 Light-on Type with Buzzer(LED)		Y	黃 Yellow			
ADLTF	閃爍式附警報器 Flashing Type with Buzzer(LED)	G	綠 Green					
2. 電壓 Voltage	12	DC12V	Bu	藍 Blue				
	24	DC24V	W	白 White				
	110	AC110V						
	220	AC220V						
5. 腳架 Mount	A	L 鐵 L Iron Tube	B	法蘭座 Flange Mount	C	盤式 Dish Mount	D	可調式法蘭座 Adjustable Flange Mount

桿燈腳架種類 Lamp Mounts Available :

A : L鐵 L Iron Tube

B : 法蘭座 Flange Mount

C : 盤式 Dish Mount

D : 可調式法蘭座 **NEW**  
Adjustable Flange Mount

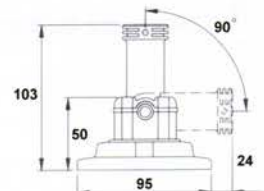
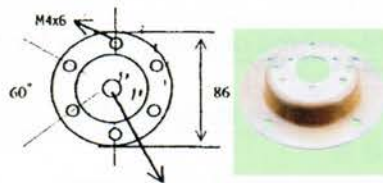
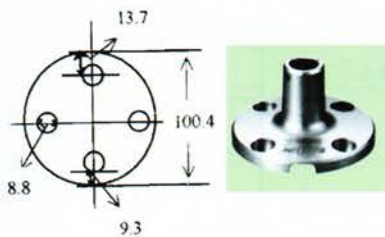
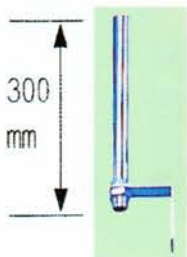



# Φ57mm Signal Tower Light

Φ57mm 多層式信號燈

• LT • LTF - [ ] [ ] - R Y G - A  
 • DLT • DLTF - [ ] [ ] - R Y G - A

1.	桿燈可由 1 層追加至 5 層 The tower light is free to assembly from 1 to 5 layers
2.	額定電壓為 12V 至 220V The rated voltage is from 12V to 220V
3.	可選擇採用點燈式或閃爍式 You may select light-on type or flashing type for the LT
4.	可選擇使用鎢絲燈泡或 LED 燈泡 Both tungsten lamp and LED are compatible for the LT

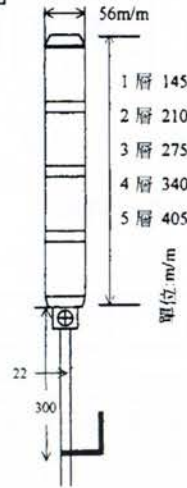

• ALT • ALTF - [ ] [ ] - R Y G - B

1.	桿燈可由 1 層追加至 5 層 The tower light is free to assembly from 1 to 5 layers
2.	額定電壓為 12V 至 220V The rated voltage is from 12V to 220V
3.	可選擇採用點燈式或閃爍式 You may select light-on type or flashing type for the LT
4.	本系列桿燈使用鎢絲燈泡 The ALT and ALTF series are applying tungsten lamp
5.	本系列桿燈均附警報器 The ALT and ALTF series are all with buzzer
6.	ALTF 110V 220V 須於底座加裝 1 層 An extra bottom layer is required for ALTF 110V 220V

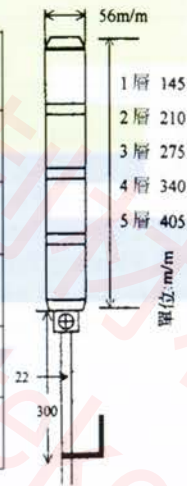

• ADLT • ADLTF - [ ] [ ] - R Y G - C

1.	桿燈可由 1 層追加至 5 層 The tower light is free to assembly from 1 to 5 layers
2.	額定電壓為 12V 至 220V The rated voltage is from 12V to 220V
3.	可選擇採用點燈式或閃爍式 You may select light-on type or flashing type for the LT
4.	本系列桿燈使用 LED 燈泡 The ALT and ALTF series are applying LED
5.	本系列桿燈均附警報器 The ALT and ALTF series are all with buzzer
6.	ADLTF 110V 220V 須於底座加裝 1 層 An extra bottom layer is required for ADLTF 110V 220V

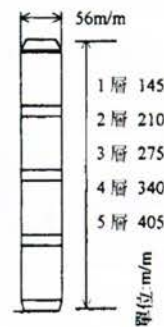





# Φ40mm LED Signal Tower Light

型號說明 Model Designation :

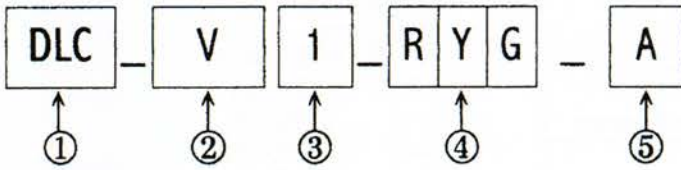

AC/DC 24V型

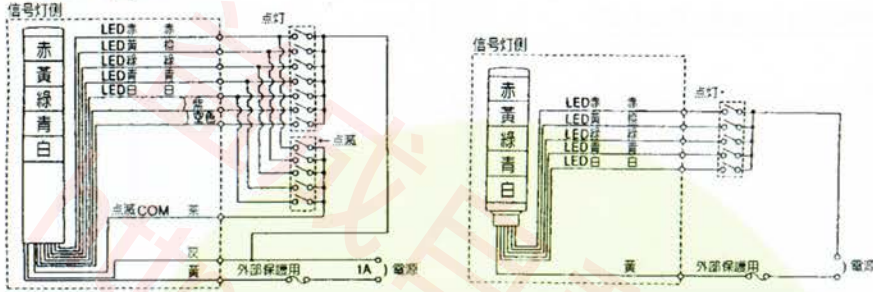

Φ 40 mm LED 多層式信號燈

項次 Item	代號 Model No.	說明 Description	項次 Item	代號 Model No.	說明 Description			
1. 型式 Type	DLC	點燈式 Light-on Type (LED)	3. 層數 Layer	1	1層 1 Layer			
	DLCF	閃爍式 Flashing Type (LED)		2	2層 2 Layers			
	ADLC	點燈式附警報器 Light-on Type with Buzzer(LED)		3	3層 3 Layers			
	ADLCF	閃爍式附警報器 Flashing Type with Buzzer(LED)		4	4層 4 Layers			
				5	5層 5 Layers			
2. 電壓 Voltage	12 24 110 220	DC12V DC24V AC110V AC220V	4. 顏色 Color	R Y G B W	紅 Red 黃 Yellow 綠 Green 藍 Blue 白 White			
5. 腳架 Mount	A	L 鐵 L Iron Tube	B	法蘭座 Flange Mount	C	盤式 Dish Mount	D	可調式法蘭座 Adjustable Flange Mount

桿燈腳架種類 Lamp Mounts Available :

A : L鐵 L Iron Tube

B : 法蘭座 Flange Mount

C : 盤式 Dish Mount

D : 可調式法蘭座 **NEW**  
Adjustable Flange Mount

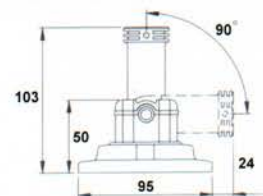
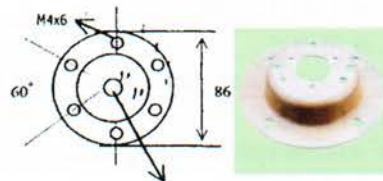
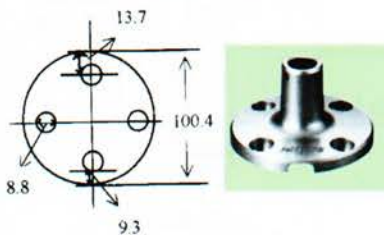
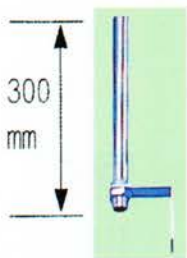



## Φ40mm LED Signal Tower Light

Φ40mm LED 多層式信號燈

• DLC -   - R Y G - A

1.	桿燈可由 1 層追加至 5 層 The tower light is free to assembly from 1 to 5 layers
2.	額定電壓為 12V 至 220V The rated voltage is from 12V to 220V
3.	可選擇採用點燈式或閃爍式 You may select light-on type or flashing type for the LC
4.	本系列桿燈使用 LED 燈泡 The DLC series are applying LED

外觀圖 (mm)

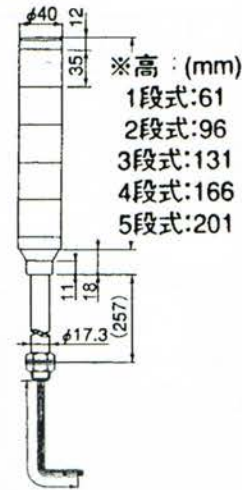

※高 (mm)  
1 段式: 61  
2 段式: 96  
3 段式: 131  
4 段式: 166  
5 段式: 201



• DLCF -   - R Y G - A

1.	桿燈可由 1 層追加至 5 層 The tower light is free to assembly from 1 to 5 layers
2.	額定電壓為 12V 至 220V The rated voltage is from 12V to 220V
3.	可選擇採用點燈式或閃爍式 You may select light-on type or flashing type for the LC
4.	本系列桿燈使用 LED 燈泡 The DLCF series are applying LED

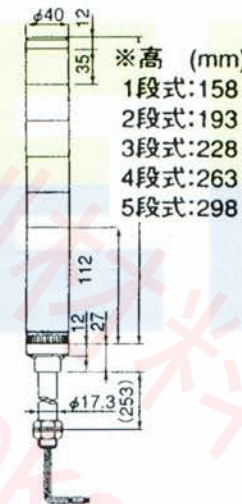

※高 (mm)  
1 段式: 158  
2 段式: 193  
3 段式: 228  
4 段式: 263  
5 段式: 298



• ADLC •ADLCF -   - R Y G - A

1.	桿燈可由 1 層追加至 5 層 The tower light is free to assembly from 1 to 5 layers
2.	額定電壓為 12V 至 220V The rated voltage is from 12V to 220V
3.	可選擇採用點燈式或閃爍式 You may select light-on type or flashing type for the LC
4.	本系列桿燈使用 LED 燈泡 The ALT and ALTF series are applying LED
5.	本系列桿燈均附警報器 The ADLC and ADLCF series are all with buzzer

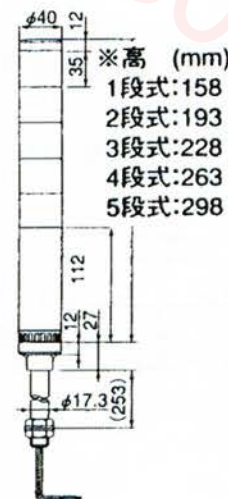

※高 (mm)  
1 段式: 158  
2 段式: 193  
3 段式: 228  
4 段式: 263  
5 段式: 298







# Square Signal Tower Light (with Siren)

方形多層式信號燈 (附警報器)

- EJ-1 (可使用LED/ LED Compatible)

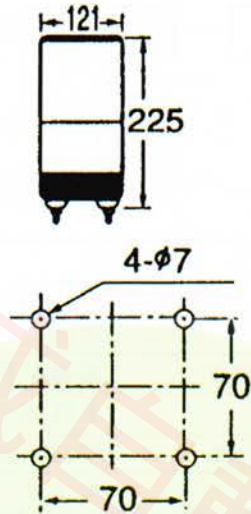

電壓 VOLTAGE	AC110V/220V DC12V~24V
燈泡 BULB	12V5W 24V10W
顏色 COLOR	<span style="color:red">■</span> 紅 <span style="color:yellow">■</span> 黃 <span style="color:blue">■</span> 藍 <span style="color:green">■</span> 綠

- EJ-2 (可使用LED/ LED Compatible)

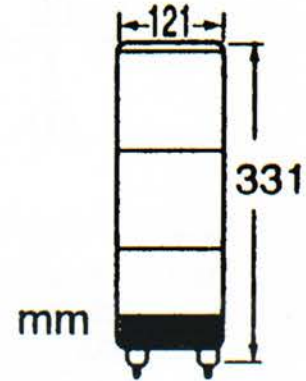

電壓 VOLTAGE	AC110V/220V DC12V~24V
燈泡 BULB	12V5W 24V10W
顏色 COLOR	<span style="color:red">■</span> 紅 <span style="color:yellow">■</span> 黃 <span style="color:blue">■</span> 藍 <span style="color:green">■</span> 綠

- EJ-3 (可使用LED/ LED Compatible)

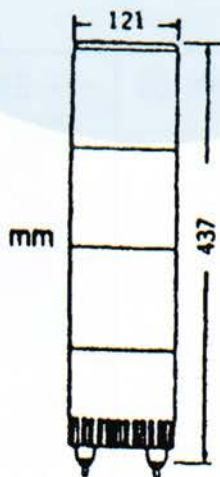
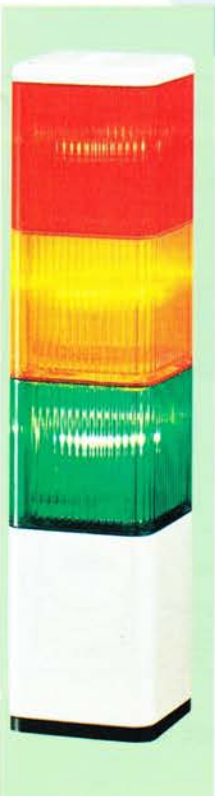

電壓 VOLTAGE	AC110V/220V DC12V~24V
燈泡 BULB	12V5W 24V10W
顏色 COLOR	<span style="color:red">■</span> 紅 <span style="color:yellow">■</span> 黃 <span style="color:blue">■</span> 藍 <span style="color:green">■</span> 綠

- EJ-□ S 附警報器 WITH SIREN (1~3層)  
(可使用LED/ LED Compatible)

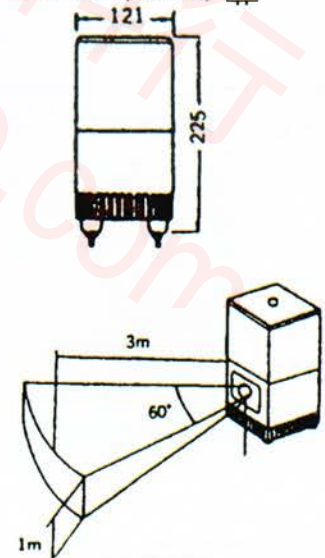

電壓 VOLTAGE	AC110V/220V DC12V~24V
燈泡 BULB	12V5W 24V10W
顏色 COLOR	<span style="color:red">■</span> 紅 <span style="color:yellow">■</span> 黃 <span style="color:blue">■</span> 藍 <span style="color:green">■</span> 綠



# Warning Light

型號說明 Model Designation :

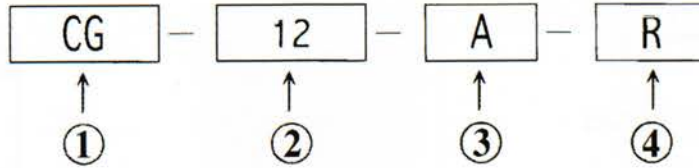

項次 Item	代號 Model No.	說明 Description							
1. 型式 Type	CG-30	Revolving Light						旋轉式	
	EM(F)	Revolving Light Flashing Type						旋轉閃爍式	
	EMX	Magnetic Revolving Light						車用磁吸式	
	EA(F)	Revolving Light Flashing Type						旋轉閃爍式	
	GLX	Revolving Light						旋轉式	
	EAS	Revolving Light with Buzzer						旋轉式附警報器	
	GLXS	Revolving Light with Buzzer						旋轉式附警報器	
	SF(S)	Magnetic Revolving Light with Buzzer						磁吸式附警報器	
	SFL(S)	Magnetic Revolving Light with Buzzer						磁吸式附警報器	
2. 電壓 Voltage	110	110V	220	220V	380	380V	440	440V	
	6	AC6V(DC)	12	AC12V(DC)	24	AC24V(DC)			
3. 電流 Ampere	A	AC 交流電 Alternate Current							
	D	DC 直流電 Direct Current							
4. 顏色 Color	R	紅 Red	G	綠 Green	Y	黃 Yellow	Bu	藍 Blue	

• CG-30 (可使用LED/ LED Compatible)

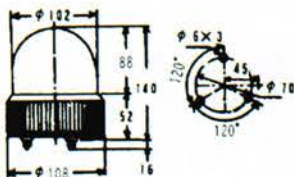

電壓 : VOLTAGE DC12/24 AC110/220

• EM (可使用LED/ LED Compatible)

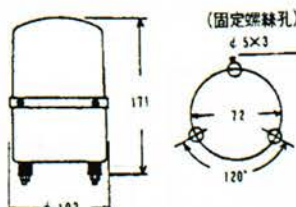

電壓 : VOLTAGE DC6/12/24 AC110/220

• EMX (可使用LED/ LED Compatible)

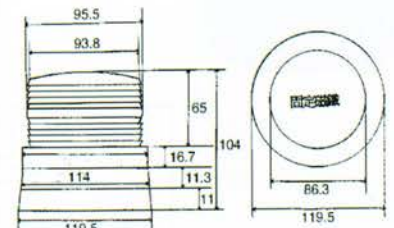

電壓 : VOLTAGE DC6/12/24





# Warning Light (with Siren)

警示燈 (可附警報器)

• EA (可使用LED/LED Compatible)



型 式 MODEL	電 壓 VOLTAGE	電 流 CURRENT	閃 光 數 FLASHES PER-MINUTE	燈 泡 BULB
EA-6	DC 6V	1.7	150RPM	6V 10W
EA-12	DC 12V	0.85		12V 10W
EA-24	DC 24V	0.42		24V 10W
EA-110	AC 110V	0.1		12V 10W
EA-220	AC 220V	0.05		12V 10W

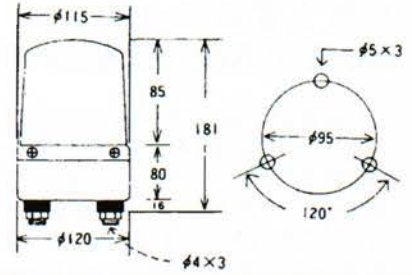

• GLX (可使用LED/LED Compatible)



型 式 MODEL	電 壓 VOLTAGE	電 流 CURRENT	閃 光 數 FLASHES PER-MINUTE	燈 泡 BULB
GLX-12	DC 12V	3A	180RPM	12V 35W
GLX-24	DC 24V	1.9A		24V 50W
GLX-110	AC 110V	0.37A		110V 40W
GLX-220	AC 220V	0.2A		220V 40W

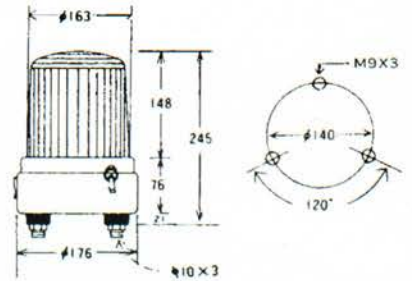

• EAS (附警報器) With Siren

(可使用LED/LED Compatible)



型 式 MODEL	電 壓 VOLTAGE	電 流 CURRENT	閃 光 數 FLASHES PER-MINUTE	燈 泡 BULB
EAS-6	DC 6V	1.7	150RPM	6V 10W
EAS-12	DC 12V	0.85		12V 10W
EAS-24	DC 24V	0.42		24V 10W
EAS-110	AC 110V	0.1		12V 10W
EAS-220	AC 220V	0.05		12V 10W

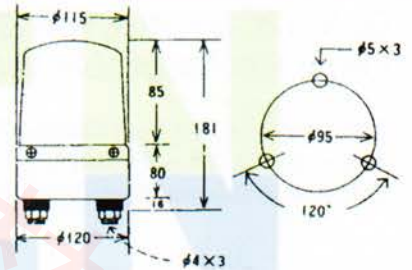

• GLXS (附警報器) With Siren

(可使用LED/LED Compatible)



型 式 MODEL	電 壓 VOLTAGE	電 流 CURRENT	閃 光 數 FLASHES PER-MINUTE	燈 泡 BULB
GLXS-12	DC 12V	3A	180RPM	12V 35W
GLXS-24	DC 24V	1.9A		24V 50W
GLXS-110	AC 110V	0.37A		110V 40W
GLXS-220	AC 220V	0.2A		220V 40W

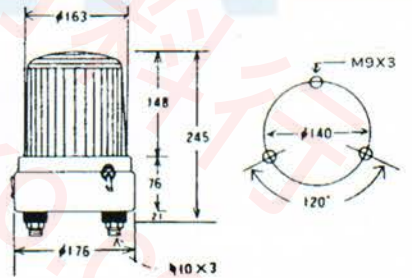

• SF(S) (可使用LED/LED Compatible)



型 式 MODEL	電 壓 VOLTAGE	電 流 CURRENT	閃 光 數 FLASHES PER-MINUTE	燈 泡 BULB
SF-12	DC 12V	1.7A	160RPM	12V 20W
SF-24	DC 24V	0.8A		24V 20W
SFS-12	DC 12V	1.8A	(附警報聲)	12V 20W

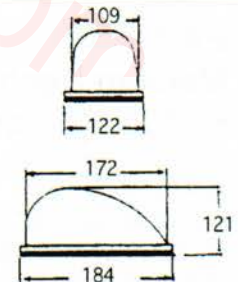

• SFL (可使用LED/LED Compatible)



型 式 MODEL	電 壓 VOLTAGE	電 流 CURRENT	閃 光 數 FLASHES PER-MINUTE	燈 泡 BULB
SFL-12	DC 12V	2.7A	160RPM	12V 35W
SFL-24	DC 24V	1.9A		24V 50W
SFLS-12	DC 12V	2.7A	(附警報聲)	12V 35W

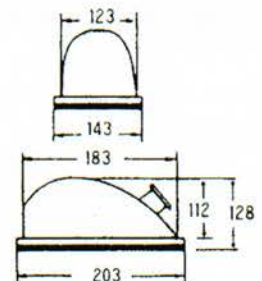





## Rechargeable Warning Light

充  
電  
式  
警  
示  
燈

### 中型充電箱警示燈 Medium Rechargeable Warning Light AC110V

EA-6FB 6V10A & 6V4A 免加水電池 Maintenance Free Battery  
 充電一次可使用14小時 Every time recharged can serve for 14 hours  
 EA-6TB 6V10A x 2 免加水電池 2只 Maintenance Free Battery x 2  
 充電一次可使用20小時 Every time recharged can serve for 20 hours  
 EA-12CB 12N-24-4 加水電池 Fast Charge Battery (Water refilling required)  
 充電一次可使用8小時 Every time recharged can serve for 8 hours



### GLX-12CB 大型充電箱警示燈 Large Rechargeable Warning Light AC110V

12N-24-4 加水電池 Fast Charge Battery (Water refilling required)  
 充電一次可使用8小時 Every time recharged can serve for 8 hours  
 雙向式旋轉燈 2-way revolving light

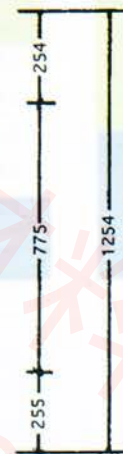

### EA-6LED 中型充電箱 LED 警示燈 Medium Rechargeable LED Warning Light AC110V 6V10A 免加水電池 Maintenance Free Battery

EA-6LED-R  
 LED 壽命 Service Life : 100,000 hrs  
 6V10A 免加水電池 Maintenance Free Battery  
 自動感光燈頭 (或不感光)  
 Automatic photoactive light bulb socket or non-photoactive  
 充電一次可使用20天 Every time recharged can serve for 20 days







## Tripod Warning Light Solar Power Warning Light

### EA-YS 中型腳架式警示燈 Medium Tripod Warning Light

EA-12YS 使用乾電池，密藏於燈架鋼管內

EA-12YS uses dry battery and it is hidden in the steel tube of the tripod

警示燈外型、尺寸及規格與EA、EB型相同

The shape, size, and specification is the same with the EA and EB type

輕巧簡便，適合任何施工現場使用

Easy for mounting and suitable for any construction site

電壓 Voltage : 110V、220V

型式 Type	電壓 Voltage	腳架伸縮高度 Tripod Stretching Height	腳架展開直徑 Tripod Expanding Diam	總重量 Total Weight
EA-110YS	AC110V	1030~1540	Φ1000	4kg
EA-220YS	AC220V	1030~1540	Φ1000	4kg
EA-12YS	DC12V	1000~1490	Φ1000	4.5kg
EB-110YS	AC110V	1070~1600	Φ1000	6.5kg
EB-220YS	AC220V	1070~1600	Φ1000	6.5kg

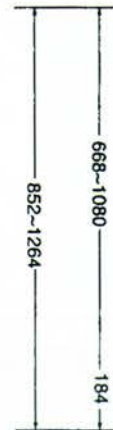

### GLX-YS 大型腳架式警示燈 Large Tripod Warning Light

電壓 Voltage : 110V、220V

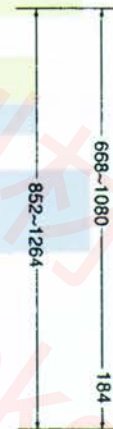

### ES-0801

太陽能警示燈 Solar Power Energy Warning Light

ES-0801-YS

腳架式太陽能警示燈

Tripod Solar Power Energy Warning Light

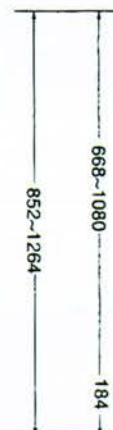



## Obstruction Light Traffic Light

航空燈、停車場紅綠燈

CT-15 大型高樓航空燈 Large Obstruction Light

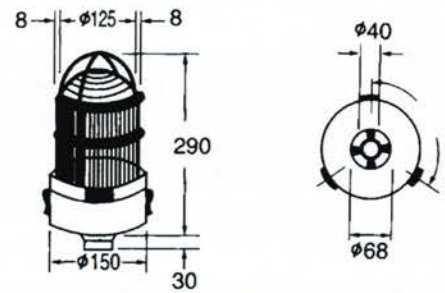

電壓 : VOLTAGE : AC110/220V

CT-25 小型高樓航空燈 Small Obstruction Light

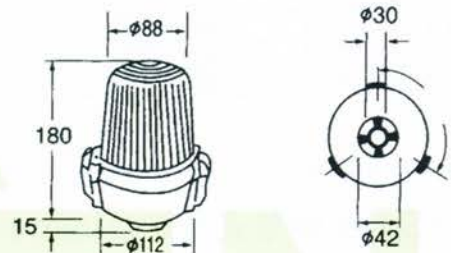

電壓 : VOLTAGE : AC110/220V

PC-U 直式停車場紅綠燈 Vertical Traffic Light

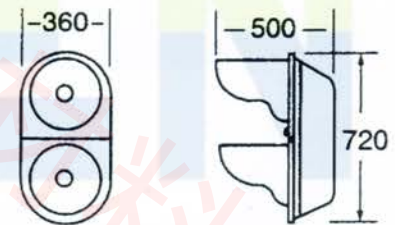
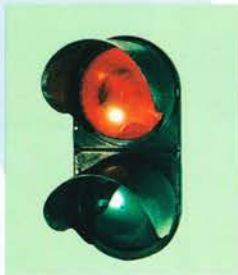

燈泡 : BULB 100W  
電壓 : VOLTAGE : AC110/220V

PC-C 橫式停車場紅綠燈 Horizontal Traffic Light

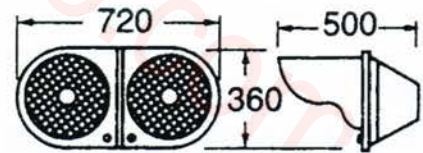
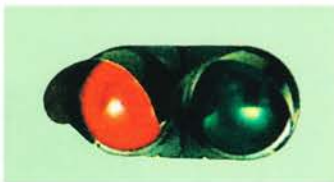

燈泡 : BULB 100W  
電壓 : VOLTAGE : AC110/220V

PC-S 電子式號誌主機 Electrical Signal Main Unit



電源 Power : 110V  
功能 Function :  
具紅燈閃爍復歸延遲可配合車道捲門、柵欄機  
The red light flashing and momentary delay provide good coordination with rolling shutters and hurdles