

# FOOT SWITCHES

Made in Japan

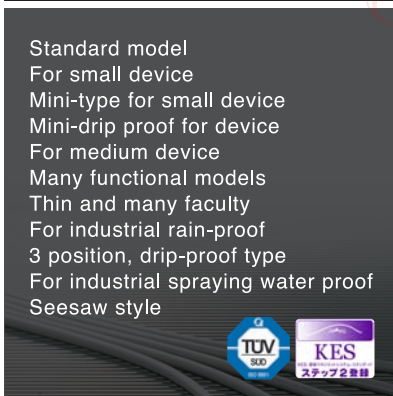
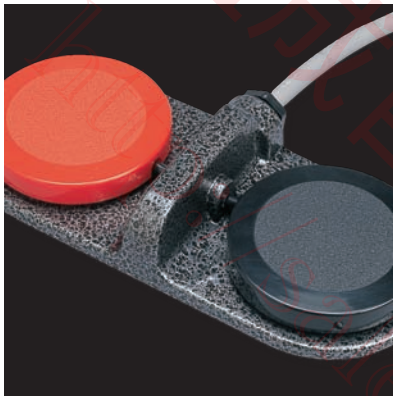

# P Series

It is thin long life, it can make 360° in many faculty of software touch and hand, leg and knee etc.

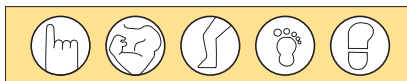

Color	B:(Black)	R:(Red)	W:(White)
-------	-----------	---------	-----------

### Features

- Operation acts 360° at every position.
- Perfect to operation of hand, elbow, leg, knee.
- ABS resin of resistance impact, resistance insulation is used.
- It is economical in low price.
- 3 colors standard.

### Major Applications

Medical appliances, Measuring device, Industrial electron device, Industry sewing machine, Sound device, Education device, Communications device, Photo device, Public welfare device, Each automation device, Others

## Thin and many faculty

### ● OFL-□-P□Color Type

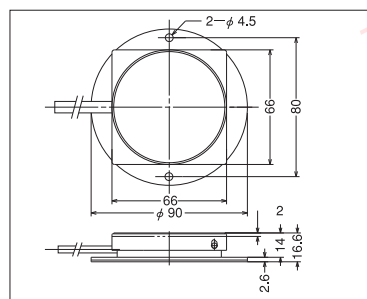
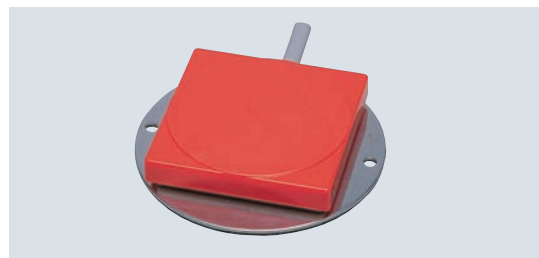

With protection cover (Option)

### ● OFL-□-PC Type

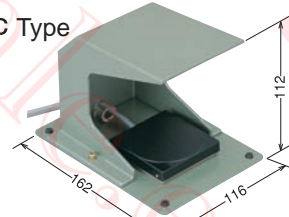

## Low Price Type

### ● OFL-□-P2□Color Type

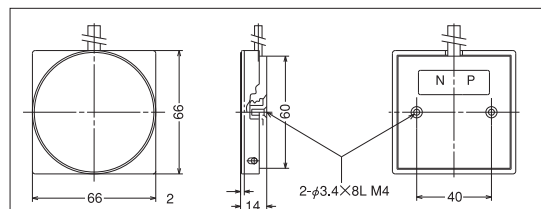
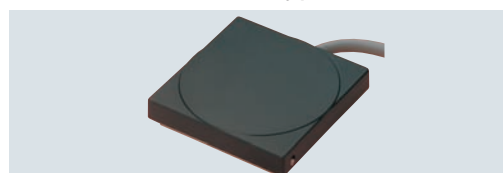

◆ Attachment hole is 2 places (back hole diameter φ 3.4 X depth 8 bag style). Please go M4 tapping screw B1 on use in length 6~8mm of availability screw in tightening torque 78.4N.

## Cord is put out from under

### ● OFL-□-P3□Color Type

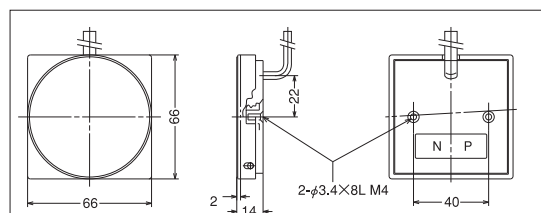

## With magnet base

### ● OFL-□-PM□Color Type

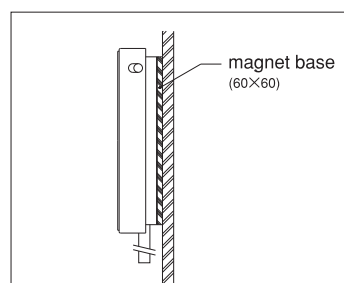
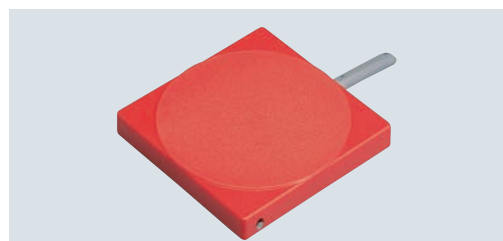

### Features

- Attachment the place of operation that it is free! Flat steel plate, easy set. (Attachment construction work is not needed.)



◆ Please pay attention to periphery device because of strong magnetic force.

## Twin Type

### ● OFL-T□-P Type

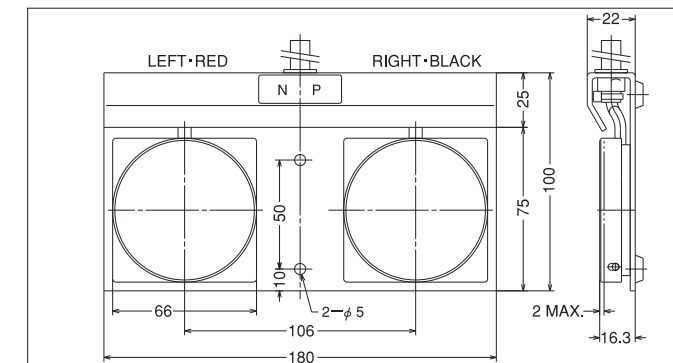
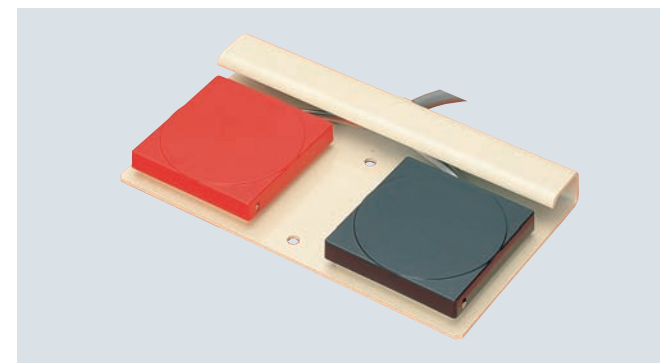

## With protection cover

### ● OFL-T□-PC Type

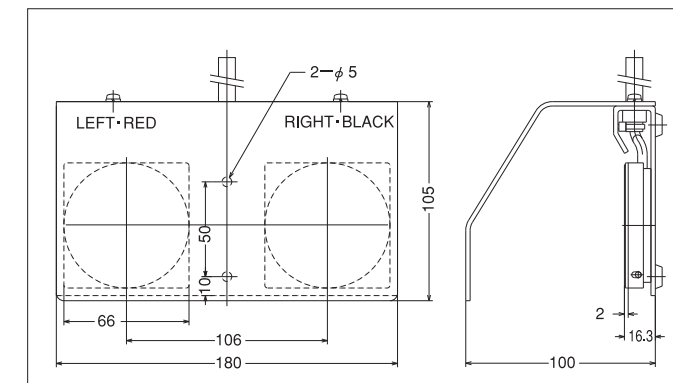
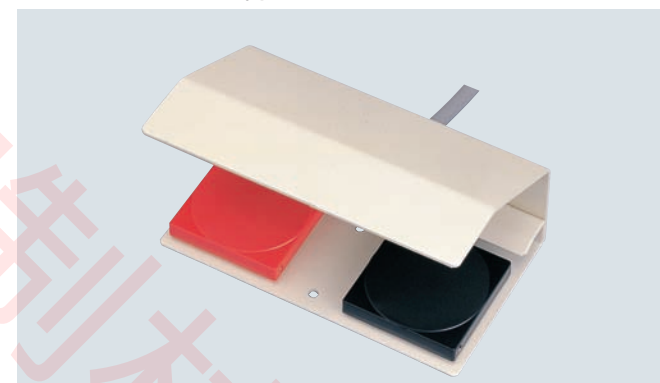

## P series

Type	Protection Cover		Function	Rating	Switch	Contact	VCTF cord	Operating force N	Weight g
	C	CS							
OFL- S - P□Color	—	—	● Momentary	5A-250VAC	MICRO Switch	1a	0.75mm <sup>2</sup> 2c 1.5m	g (0.9kgf)	190
OFL- S - P2□Color	○	○	●						120
OFL- S - P3□Color	—	—	●						180
OFL- S - PM□Color	—	—	●						750
OFL- TS - P	○	—	● Twin Type	0.1A-30VDC Minimum Load 1mA-5VDC	S (gold clad contact)	1a	0.75mm <sup>2</sup> 2c 1.5m	g (0.9kgf)	190
OFL- SG - P□Color	—	—	●						120
OFL- SG - P2□Color	○	○	●						180
OFL- SG - P3□Color	—	—	●						750
OFL- TSG - P	○	—	● Twin Type			1c for each side	VCTF0.75mm <sup>2</sup> 6c 1.5m		190

※ If marked ○, the type permits the use of the cover. If to be attached, add its weight to the weight of the switch type being used.

## Seal structure switch inclusion type

(IP class as indicated or equivalent)

OFL-SG5-P□Color	—	—	●	0.1A-30VDC Minimum Load 5mA-6VDC	(IP50) S (gold clad contact)	1a	0.75mm <sup>2</sup> 2c 1.5m	g (0.9kgf)	190
OFL-SG5-P2□Color	○	○	●						120
OFL-SG5-P3□Color	—	—	●						180
OFL-SG5-PM□Color	—	—	●						

※ The protection cover OFL-C weighs 610 g (approx.) while the stainless steel cover (OFL-CS) weighs 1,310 g (approx.).