

CONTROLLER UNIT 電源供給控制器

PU-NC

DIMENSIONS(mm)
尺寸

50H×40W×57.5D

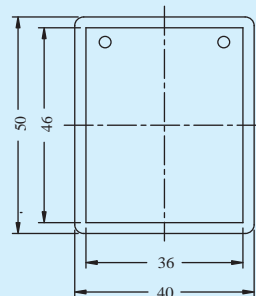

SURFACE(-N)
露出型

PF085A & SH-3

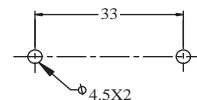
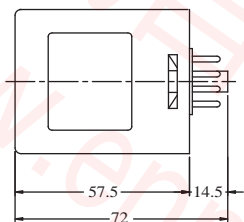

FUNCTIONS
功能特性

- Power supply for proximity and photoelectric switches
- Without change DIP switch
- can use for PNP or NPN type proximity switches
- With DCV stabilizing device
- 近接光電開關用電源供給控制器
- 不需切換開關可用於電壓型(P型)及電流型(N型)
- 輸出電源具有隱壓裝置

PU-NC 輸出接點:1C5A

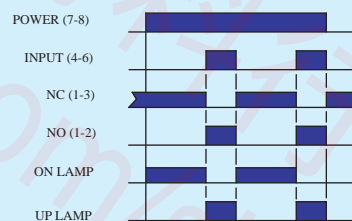

RATED VOLTAGE
額定電壓 AC(V): 110, 220, 240, 380, 415, 440, 50/60Hz

INDICATOR OPERATING
指示燈動作 ON-UP TWO indicator lamp
ON-UP 兩只指示燈

L I F E	MECHANICAL 機械	5×10 ⁶ times
	ELECTRICAL 電氣	10 ⁵ times

SETTING ERROR
設定誤差 --

RESET TIME
復歸時間 --

CONSUMED POWER
消耗功率 2VA





AMBIENT TEMPERATURE
使用周圍溫度 -10°C ~ +55°C

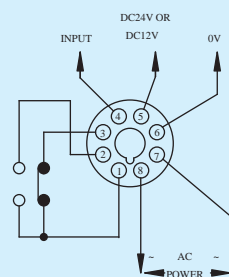

AMBIENT HUMIDITY
使用周圍濕度 45~85%RH

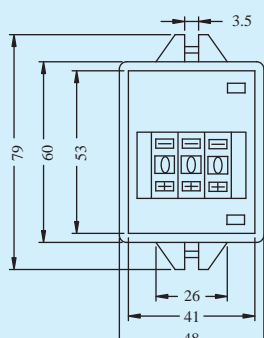
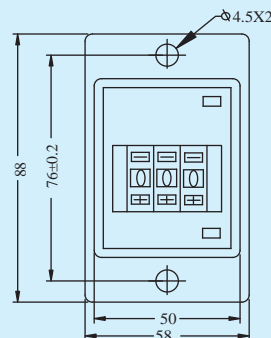
WEIGHT
重量 130g

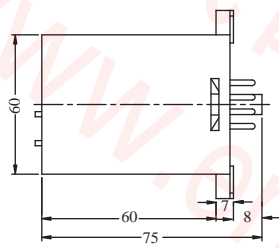

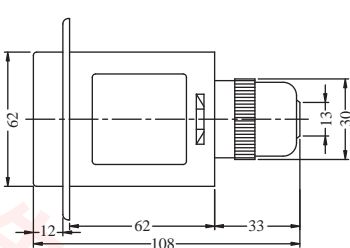
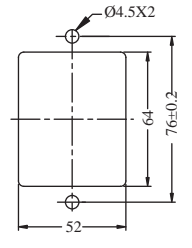
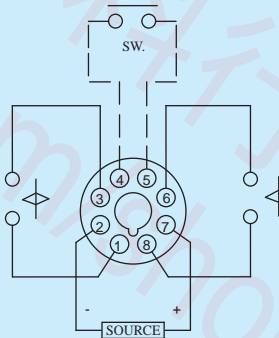
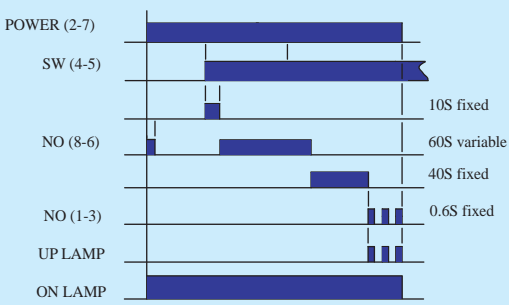
CONTROLLER UNIT
電源供給控制器

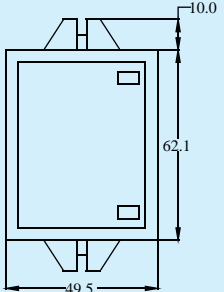
CTW-N		CTW-Y	
DIMENSIONS(mm) 尺寸	60H×48W×75D 	DIMENSIONS(mm) 尺寸	88H×58W×75D 
			
SURFACE(-N) 露出型	8PFA	FLUSH(-Y) 埋入型	US-08, P3G-08
			
FULL TIMING RANGE 時間範圍	SEC: 999S	CTW-N/Y 限時 1C 5A	
RATED VOLTAGE 額定電壓	AC(V): 110, 220, 240, 415 50/60Hz		
INDICATOR OPERATING 指示燈動作	After contact transfer 動作後指示		
L I F E 壽命	MECHANICAL 機械	5×10 ⁶ times	
	ELECTRICAL 電氣	10 ⁵ times	
A C C U R A C Y 精確度	TIME ERROR 時間誤差	± 0.05% sec	
	REPEAT ERROR 往復誤差	± 0.03% sec	
	SETTING ERROR 設定誤差	0	
	VOLTAGE ERROR 電壓誤差	± 0.05% sec	
	TEMP. ERROR 溫度誤差	± 0.05% sec	
RESET TIME 復歸時間	0.1 sec max		
CONSUMED POWER 消耗功率	2VA		
AMBIENT TEMPERATURE 使用周圍溫度	-10°C ~ +55°C		
AMBIENT HUMIDITY 使用周圍濕度	45~85%RH		
WEIGHT 重量	230g		
			
			

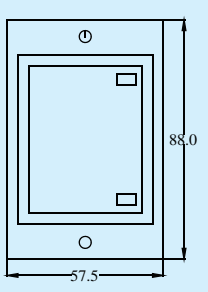
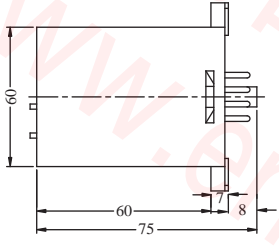
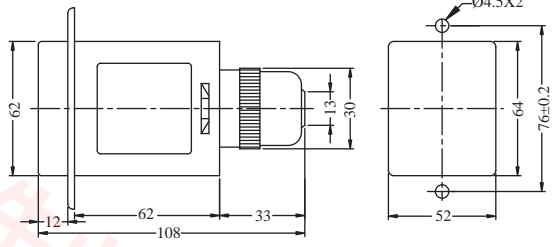
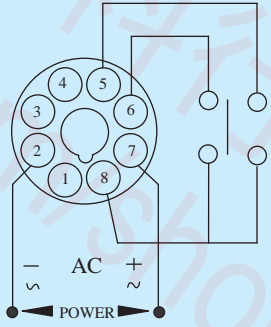
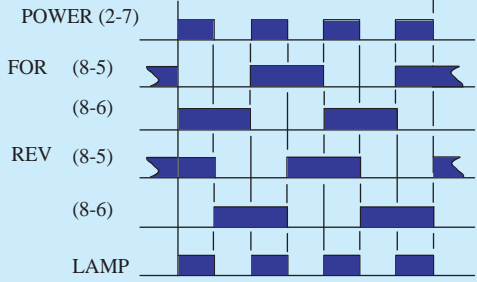
LATCH RELAY 鎖存蓄電器			
H2Q-N		H2Q-Y	
DIMENSIONS(mm) 尺寸		DIMENSIONS(mm) 尺寸	
60H×48W×75D		88H×58W×75D	
			
SURFACE(-N) 露出型		FLUSH(-Y) 埋入型	
8PFA		US-08, P3G-08	
			
FUNCTIONS 功能特性		T2C-NX/YX 限時 1C 5A, 瞬時 1C 1+4 Count input 1+3 Reset	
<ul style="list-style-type: none"> With 2C (D.P.D.T) contact, it can choose positive edge trigger (power on) or negative edge trigger (power off) operation Contact can keep on after power off, and contact can revolve when next signal trigger. 具有2C接點, 可選擇正緣(通電)或負緣(斷電)動作。 斷電後接點可保持, 當下一次訊號來時接點可以轉換。 			
RATED VOLTAGE 額定電壓		AC(V): 240 50/60Hz	
INDICATOR OPERATING 指示燈動作		Indicator Lamp 指示燈	
L I F E	MECHANICAL 機械	5×10 ⁶ times	
	ELECTRICAL 電氣	10 ⁵ times	
SETTING ERROR 設定誤差		0	
RESET TIME 復歸時間		0.5 sec max	
CONSUMED POWER 消耗功率		3VA	
AMBIENT TEMPERATURE 使用周圍溫度		-10°C ~ +55°C	
AMBIENT HUMIDITY 使用周圍濕度		45~85%RH	
WEIGHT 重量		230g	
		 <p>POWER (2-7) FOR (8-5) REV (8-5) LAMP</p>	

REV. PREVENTING RELAY
防止逆向繼電器

APR-3

DIMENSIONS(mm)
尺寸

50H×40W×57.5D

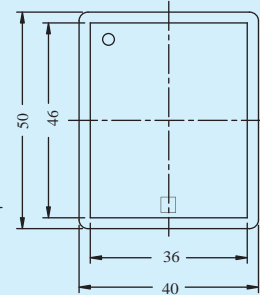

SURFACE(-N)
露出型

PF085A & SH-3

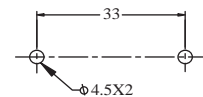
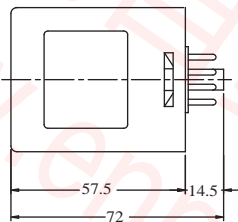

FUNCTIONS
功能特性

- Protecting three-phase induction motor reverse relay
- 220V source with surge absorber and high voltage protecting-
- 防止三相感應馬達逆相運轉
- 220V內加突波吸收器防止過高電壓，可有效保護負載

APR-3 輸出接點:1C 5A

RATED VOLTAGE
額定電壓

AC(V): 220, 240, 50/60Hz

INDICATOR OPERATING
指示燈動作

--

L I F E
壽命
MECHANICAL
機械
ELECTRICAL
電氣

5×10⁶ times

10⁵ times

SETTING ERROR
設定誤差

--

RESET TIME
複歸時間

--

CONSUMED POWER
消耗功率

2VA

AMBIENT TEMPERATURE
使用周圍溫度

-10°C ~ +55°C

AMBIENT HUMIDITY
使用周圍濕度

45~85%RH

WEIGHT
重量

90g

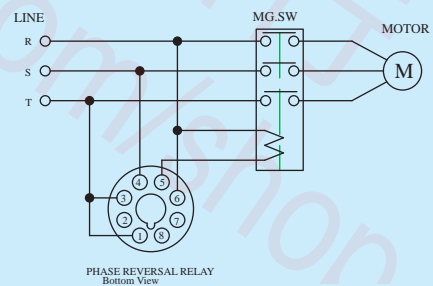

PHASE REVERSAL RELAY
Bottom View

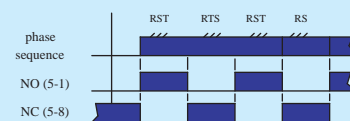

REV. PREVENTING RELAY 防止缺向逆向繼電器

APR-4

DIMENSIONS(mm)
尺寸

58H×48W×65D

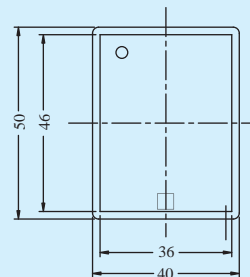

FLUSH(-Y)
埋入型

P3G-08

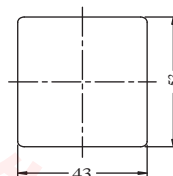
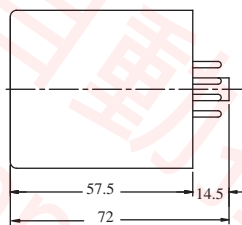

APR-4 輸出接點:1C 5A

FUNCTIONS
功能特性

- With 3 phases voltage detecting to protect motor reversal relay.
- Assure the sequence of 3 phases power source, to protect motor rev.
- The output relay is energized when the phase sequence is correct and is denegized when the phase sequence is wrong or one phase is lost.

- 可確認三相電源之相序，防止馬達逆轉
- 按圖面接線，在缺相時可防止電磁接觸器動作
- 本保護繼電器採用電壓輸出方式與負載電流無關
- 工作電壓為額定電壓95%~110%

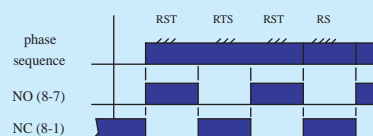
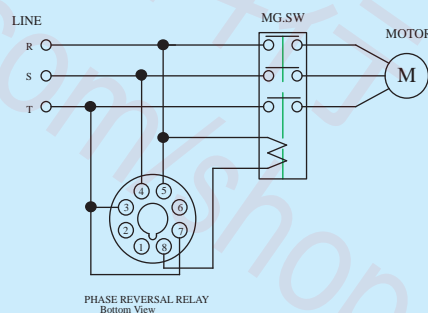

RATED VOLTAGE
額定電壓

AC(V): 380, 415, 440, 50/60Hz

INDICATOR OPERATING
指示燈動作

--

L I F E
壽命
MECHANICAL
機械
ELECTRICAL
電氣

5×10^6 times

10^5 times

SETTING ERROR
設定誤差

--

RESET TIME
複歸時間

--

CONSUMED POWER
消耗功率

2VA

AMBIENT TEMPERATURE
使用周圍溫度

-10°C ~ +55°C

AMBIENT HUMIDITY
使用周圍濕度

45~85%RH

WEIGHT
重量

90g

OFF DELAY RELAY 斷電延遲繼電器

TRF

DIMENSIONS(mm)
尺寸

50H×40W×57.5D

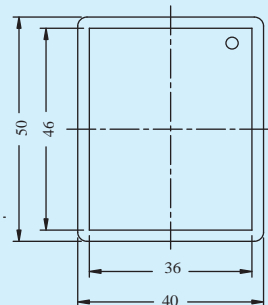

SURFACE(-N)
露出型

PF085A & SH-3

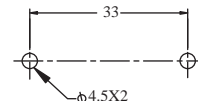
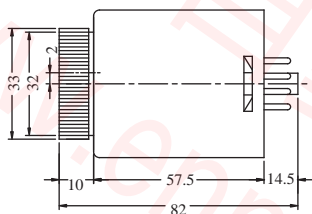

FULL TIMING RANGE
時間範圍

50ms, 100ms, 150ms, 200ms
300ms, 400ms, 500ms, 1s

TRF

限時 2C 5A

RATED VOLTAGE
額定電壓

DC(V): 12, 24
AC(V): 12, 24, 48, 110, 220, 240
380, 415, 440, 50/60Hz

INDICATOR OPERATING
指示燈動作

After contact transfer
繼電器動作指示

L I F E
壽命

MECHANICAL
機械

5×10^6 times

ELECTRICAL
電氣

10^5 times

A C R A C Y
精確度

REPEAT ERROR
往復誤差

$\pm 5\%$ max

SETTING ERROR
設定誤差

--

VOLTAGE ERROR
電壓誤差

$\pm 3.5\%$ max

TEMP. ERROR
溫度誤差

--

RESET TIME
複歸時間

--

CONSUMED POWER
消耗功率

2VA

AMBIENT TEMPERATURE
使用周圍溫度

$-10^{\circ}\text{C} \sim +55^{\circ}\text{C}$

AMBIENT HUMIDITY
使用周圍濕度



45~85%RH

WEIGHT
重量

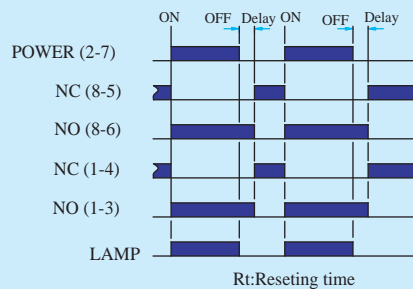
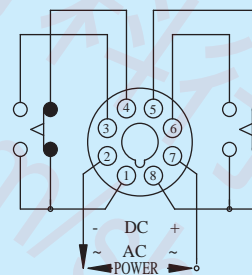
130g

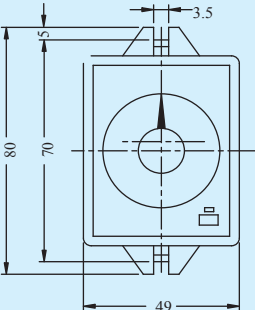

OFF DELAY RELAY
斷電延遲繼電器

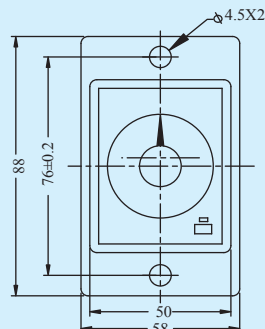
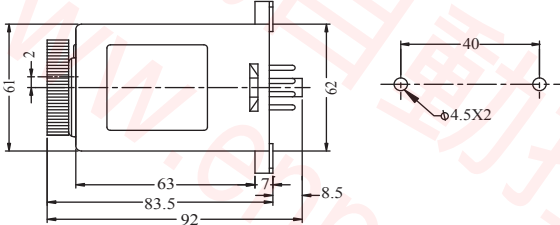
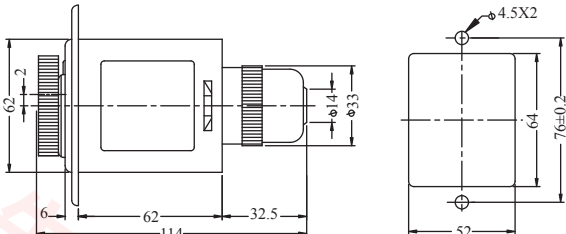
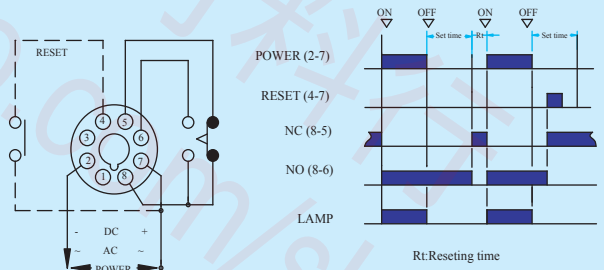
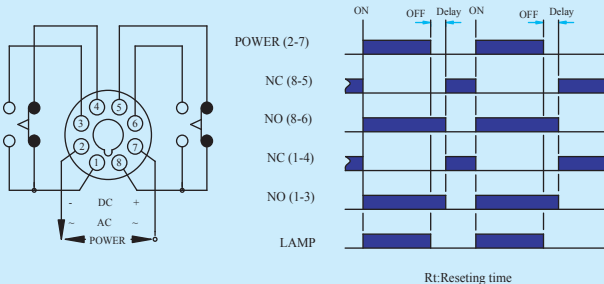
ATF-N□		ATF-Y□	
DIMENSIONS(mm) 尺寸	61H×49W×70D	DIMENSIONS(mm) 尺寸	88H×58W×68D
			
SURFACE(-N) 露出型	8PFA	FLUSH(-Y) 埋入型	US-08, P3G-08
			
FULL TIMING RANGE 時間範圍	SEC: 1, 3, 6, 10, 30, 60 MIN: 3	ATF-NA/YA 限時 1C 5A	
RATED VOLTAGE 額定電壓	DC(V): 12, 24 AC(V): 12, 24, 48, 110, 220, 240 380, 415, 440, 50/60Hz		
INDICATOR OPERATING 指示燈動作	Power on 通電指示		
L I F E 命	MECHANICAL 機械	5×10 ⁶ times	
	ELECTRICAL 電氣	10 ⁵ times	
A C C U R A C Y 精度	REPEAT ERROR 往復誤差	± 2% max	
	SETTING ERROR 設定誤差	± 10% max	
	VOLTAGE ERROR 電壓誤差	± 2% max	
	TEMP. ERROR 溫度誤差	± 2% max	
RESET TIME 複歸時間	0.3 sec max	ATF-NB/YB 限時 2C 5A	
CONSUMED POWER 消耗功率	3VA		
AMBIENT TEMPERATURE 使用周圍溫度	-10°C ~ +55°C		
AMBIENT HUMIDITY 使用周圍濕度	45~85%RH		
WEIGHT 重量	220g		

FOR-REV RELAY
正逆轉用繼電器

TWB-N

DIMENSIONS(mm)
尺寸

61H×49W×70D

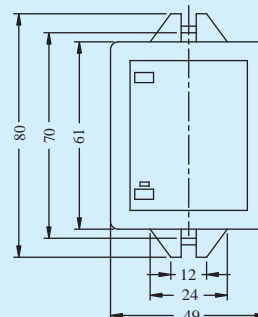

SURFACE(-N)
露出型

8PFA

SURFACE(-N)
露出型

8PFA

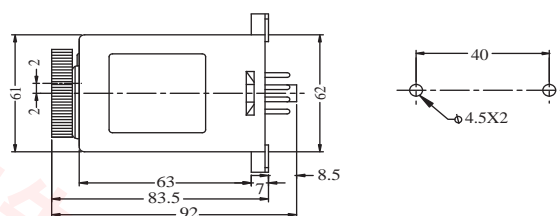
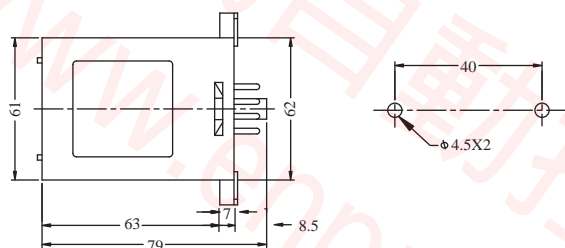

FULL TIMING RANGE
時間範圍

FOR/REV: 30S fixed upon clients' request
STOP: 3S fixed upon clients' request

TWB-N 限時 2C 5A

RATED VOLTAGE
額定電壓

DC(V): 12, 24
AC(V): 12, 24, 48, 110, 220, 240
380, 415, 440, 50/60Hz

INDICATOR OPERATING
指示燈動作

FOR-REV indicator lamp
FOR-REV 兩只指示燈

L
I
F
E

MECHANICAL
機械

5×10^6 times

ELECTRICAL
電氣

10^5 times

A
C
R
A
C
Y

REPEAT ERROR
往復誤差

$\pm 1\%$ max

SETTING ERROR
設定誤差

$\pm 10\%$ max

VOLTAGE ERROR
電壓誤差

$\pm 1.5\%$ max

TEMP. ERROR
溫度誤差

$\pm 2\%$ max

RESET TIME
複歸時間

0.1 sec max

CONSUMED POWER
消耗功率

2VA

AMBIENT TEMPERATURE
使用周圍溫度

$-10^{\circ}\text{C} \sim +55^{\circ}\text{C}$

AMBIENT HUMIDITY
使用周圍濕度

45~85%RH

WEIGHT
重量

210g

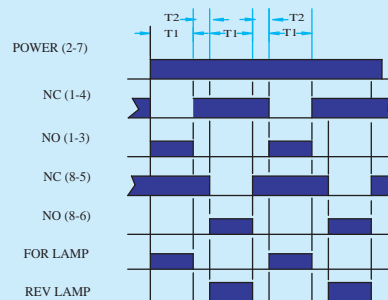
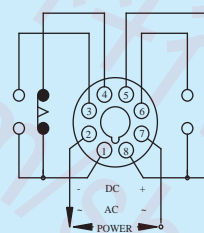

VARIABLE FOR-REV RELAY
可調式正逆轉用繼電器

TWB-ND

DIMENSIONS(mm)
尺寸

61H×49W×70D

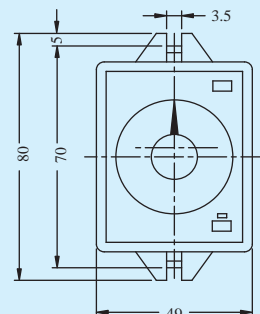

SURFACE(-N)
露出型

8PFA

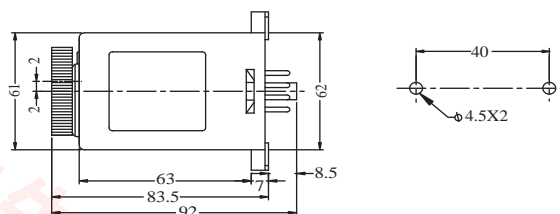
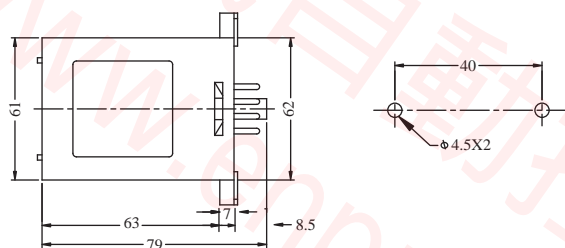

FULL TIMING RANGE
時間範圍

FOR/REV: 30S or 60S variable
STOP: 6S variable

TWB-ND

限時 2C 5A

RATED VOLTAGE
額定電壓

DC(V): 12, 24
AC(V): 12, 24, 48, 110, 220, 240
380, 415, 440, 50/60Hz

INDICATOR OPERATING
指示燈動作

FOR-REV indicator lamp
FOR-REV 兩只指示燈

L
I
F
E

MECHANICAL
機械

5×10^6 times

ELECTRICAL
電氣

10^5 times

A
C
U
R
A
C
Y

REPEAT ERROR
往復誤差

$\pm 1\%$ max

SETTING ERROR
設定誤差

$\pm 10\%$ max

VOLTAGE ERROR
電壓誤差

$\pm 1.5\%$ max

TEMP. ERROR
溫度誤差

$\pm 2\%$ max

RESET TIME
複歸時間

0.1 sec max

CONSUMED POWER
消耗功率

2VA

AMBIENT TEMPERATURE
使用周圍溫度

$-10^{\circ}\text{C} \sim +55^{\circ}\text{C}$

AMBIENT HUMIDITY
使用周圍濕度

45~85%RH

WEIGHT
重量

230g

