

Rectangular Photo Sensor

PK3

◆Shape / 外觀 :



◆Specifications / 規格表 :

Model / 型號	Pre-wired Ø4.2	PK3-DU30N	PK3-DU30P	PK3-5N	PK3-5P
	M8 Pigtailed type	PK3-DU30NB	PK3-DU30PB	PK3-5NB	PK3-5PB
Sensing type / 檢出方式	Diffuse reflection / 擴散反射式			Through beam / 對照式	
Sensing distance / 檢出距離	30 cm , white paper 300x300 (60cm)			5M	
Emitting light / 發光源	Infrared LED 850 nm			Infrared LED. 940 nm	
Operating voltage / 工作電壓	DC12 ~ 24 V				
Current Consumption / 消耗電流	25 mA Max.			40 mA Max.	
Load current / 負載電流	100mA Max. at DC24V				
Output type / 輸出模式	NPN L.on/D.on	PNP L.on/D.on	PNP L.on/D.on	NPN L.on/D.on	PNP L.on/D.on
Response time / 反應時間	1.5 ms Max.				
Insulation resistance / 隔離阻抗	20MΩ min. (DC500V)				
Voltage withstandability / 絕緣耐壓	AC1000V 60Hz for 60 Sec.				
Operating temperature/工作溫度	- 20 °C ~ + 60 °C				
Ambient humidity / 工作溼度	35% ~ 85% RH				
Protection degree / 防水等級	IP64				
Material / 外觀材質	ABS				
Wiring method / 出線方式	PK3-□N/P : Pre-wired Ø4.2 x 2 M / 4-wires PK3-□B : M8 pigtailed connector type/ M8 接頭15cm電線式(4P)				
Weight / 重量	PK3-□N/P : Approx.60g PK3-□B : Approx.20g			PK3-□N/P : Approx.115g PK3-□B : Approx.40g	

◆Dimensions/尺寸圖 :

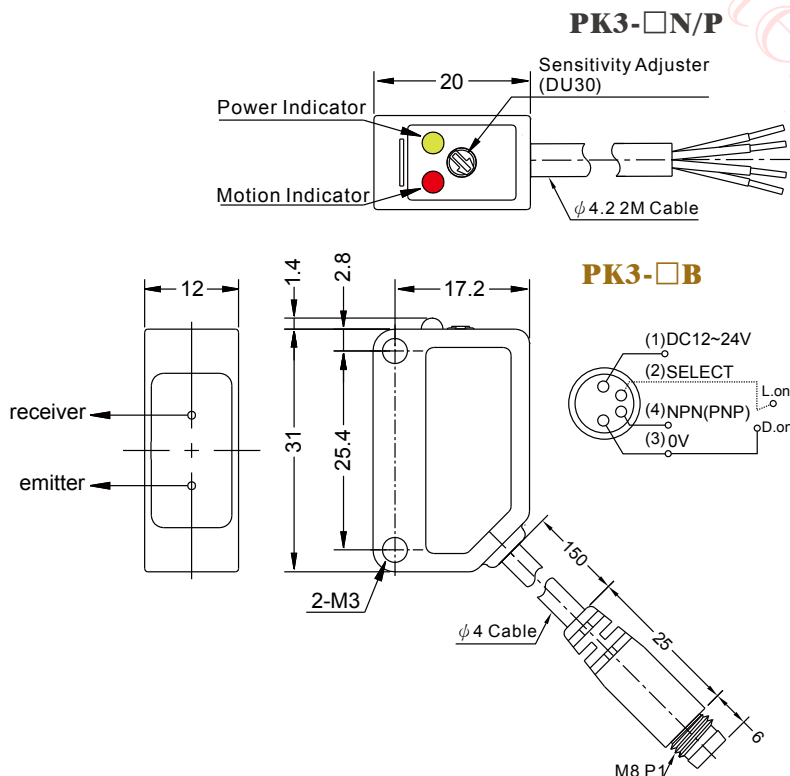

NPN Wiring diagram

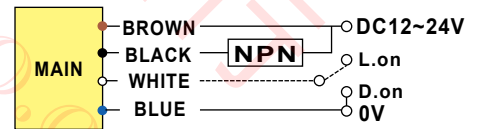

PNP Wiring diagram

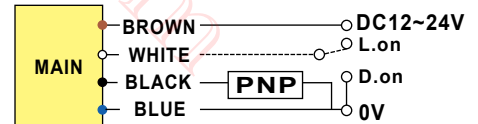

RX Wiring diagram

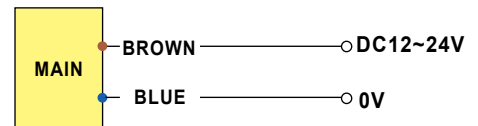

Fiber

Photo Sensor

Area Sensor

Ultrasonic Sensors

Inductive Proximity Sensor

Capacitive Proximity Sensor

Timer / Counter

Others

Accessories

PK3

Rectangular Photo Sensor

◆Characteristic / 特點：

- Visible dual LED makes you easy to know the current operating situation.
/雙LED指示燈，讓您可以很快的辨別感應品的使用狀態。
- For a better focusing, with the Non-spherical optical lens.
/非球面鏡片設計，讓您在感應物體時，更加的穩定。
- Compact size (W12xH31xD20mm), space saving.
/省空間(W12xH31xD20mm)輕薄尺寸。



◆Specifications / 規格表：

Model / 型號	Pre-wired Ø4.2	PK3-R2N	PK3-R2P
	M8 Pigtailed type	PK3-R2NB	PK3-R2PB
Sensing type / 檢出方式	Retroreflective/ 鏡片反射式		
Sensing distance / 檢出距離	2M		
Emitting light / 發光源	Infrared LED 850 nm		
Operating voltage / 工作電壓	DC12 ~ 24 V		
Current Consumption / 消耗電流	25 mA Max.		
Load current / 負載電流	100mA Max. at DC24V		
Output type / 輸出模式	NPN L.on/D.on		PNP L.on/D.on
Response time / 反應時間	1.5 ms Max.		
Insulation resistance / 隔離阻抗	20MΩ min. (DC500V)		
Voltage withstandability / 絕緣耐壓	AC1000V 60Hz for 60 Sec.		
Operating temperature/工作溫度	- 20 °C ~ + 60°C		
Ambient humidity / 工作溼度	35% ~ 85% RH		
Protection degree / 防水等級	IP64		
Material / 外觀材質	ABS		
Wiring method / 出線方式	PK3-□N/P : Pre-wired Ø4.2 x 2 M / 4-wires PK3-□B : M8 pigtailed connector type/ M8 接頭15cm電線式		
Weight / 重量	PK3-□N/P : Approx.60g PK3-□B : Approx.20g		

◆Dimensions/尺寸圖：

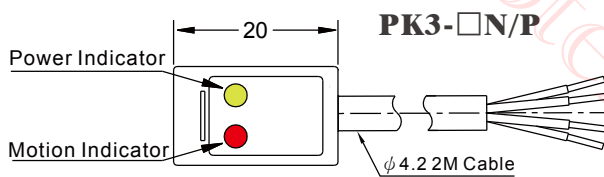

NPN Wiring diagram

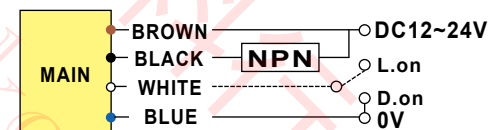

Applications / 應用

Detecting the passing of products.
/ 檢測產品通過

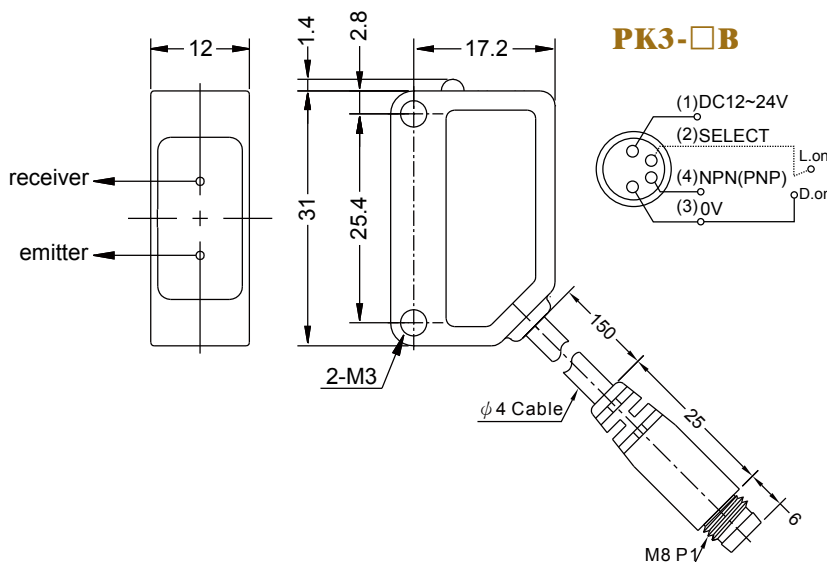
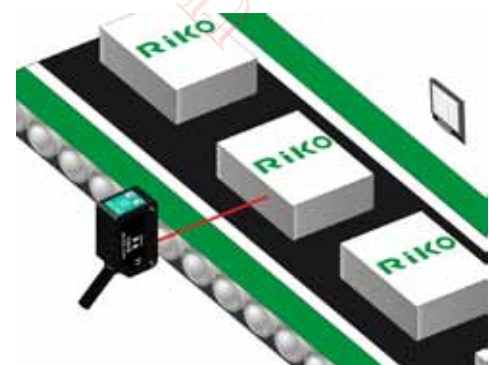

Rectangular Photo Sensor

PK3

◆Characteristic / 特點：

- Compact size (W12xH31xD20mm), space saving.
/省空間(W12xH31xD20mm)輕薄尺寸。
- Good performance on ambient illumination resistance. It has a good performance when the twist light bulb is away from 1 meter upward.
/抗干擾性高，當螺旋燈泡距離1M以上時，有相當強的抵抗性。
- The optimum sensitivity can be set easily to detect the objects at different distances.
/可調整感應度，以利不同距離的檢測。



◆Specifications / 規格表：

Model / 型號	Pre-wired Ø4.2	PK3-QM1N	PK3-QM1P
	M8 Pigtailed type	PK3-QM1NB	PK3-QM1PB
Sensing type / 檢出方式	Diffuse reflection / 擴散反射型 (紅光)		
Sensing distance / 檢出距離	10cm, 鏡片貼紙 7cm 可感應		
Emitting light / 發光源	Red LED 660 nm		
Operating voltage / 工作電壓	DC12 ~ 24 V		
Current Consumption / 消耗電流	20 mA Max.		
Load current / 負載電流	100mA Max. at DC24V		
Output type / 輸出模式	NPN L.on/D.on		PNP L.on/D.on
Response time / 反應時間	1 ms Max.		
Insulation resistance / 隔離阻抗	20MΩ min. (DC500V)		
Voltage withstandability / 絕緣耐壓	AC1000V 60Hz for 60 Sec.		
Operating temperature / 工作溫度	- 20 °C ~ + 60°C		
Ambient humidity / 工作溼度	35% ~ 85% RH		
Protection degree / 防水等級	IP64		
Material / 外觀材質	ABS		
Wiring method / 出線方式	PK3-□N/P : Pre-wired Ø4.2 x 2 M / 4-wires PK3-□B : M8 pigtailed connector type / M8 接頭15cm電線式		
Weight / 重量	PK3-□N/P : Approx.60g PK3-□B : Approx.20g		

◆Dimensions / 尺寸圖：

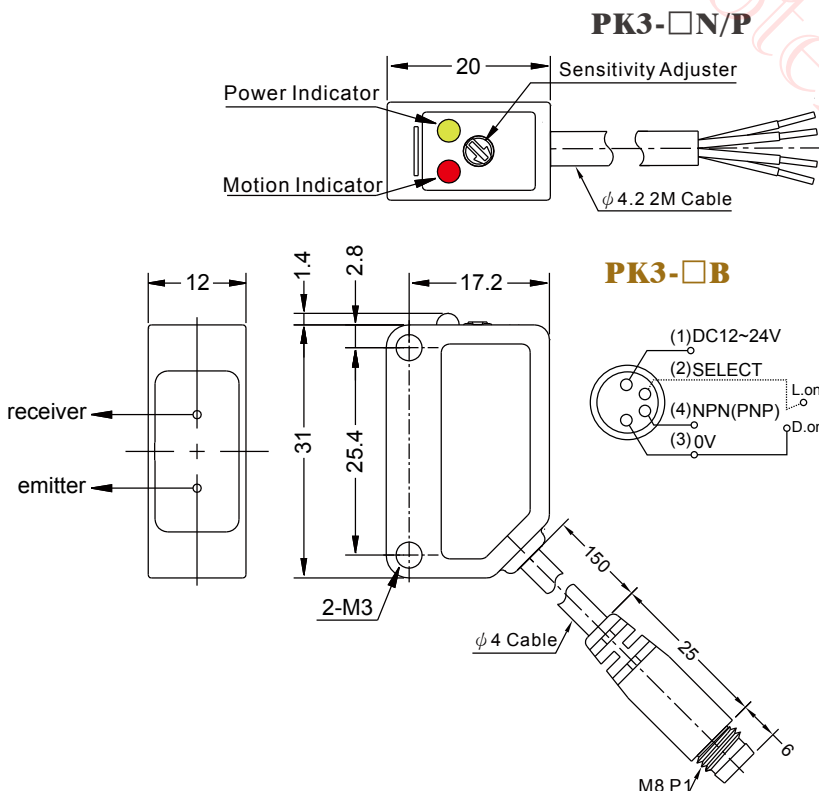

NPN Wiring diagram

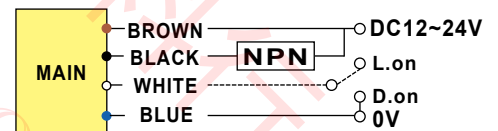

Applications / 應用

Obvious light to make its beam alignment easy. /明顯光線，使光軸更容易對焦

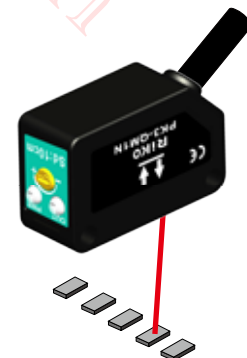

PK3

Rectangular Photo Sensor

◆Characteristic / 特點 :

- Convergent reflection type.
/限定反射型
- Not affected by colors or albedo. Any objects can be detected.
/不受顏色及反射率的影響，可來測任何被測物。
- Suitable for the stable detection of PCB.
/適用於PCB的穩定檢測



◆Specifications / 規格表 :

Model / 型號	Pre-wired Ø4.2	PK3-V03N	PK3-V03P
	M8 Pigtailed type	PK3-V03NB	PK3-V03PB
Sensing type / 檢出方式	Convergent reflection type / 限定距離反射型		
Sensing distance / 檢出距離	3cm		
Emitting light / 發光源	Infrared LED 850 nm		
Operating voltage / 工作電壓	DC12 ~ 24 V		
Current Consumption / 消耗電流	30 mA Max.		
Load current / 負載電流	100mA Max. at DC24V		
Output type / 輸出模式	NPN L.on/D.on		PNP L.on/D.on
Response time / 反應時間	1.5 ms Max.		
Insulation resistance / 隔離阻抗	20MΩ min. (DC500V)		
Voltage withstandability / 絕緣耐壓	AC1000V 60Hz for 60 Sec.		
Operating temperature/工作溫度	- 20 °C ~ + 60°C		
Ambient humidity / 工作溼度	35% ~ 85% RH		
Protection degree / 防水等級	IP64		
Material / 外觀材質	ABS		
Wiring method / 出線方式	PK3-□N : Pre-wired Ø4.2 x 2 M / 4-wires PK3-□B : M12 pigtailed connector type/ M12 接頭15cm電線式		
Weight / 重量	PK3-□N/P : Approx.60g		PK3-□B : Approx.20g

◆Dimensions/尺寸圖 :

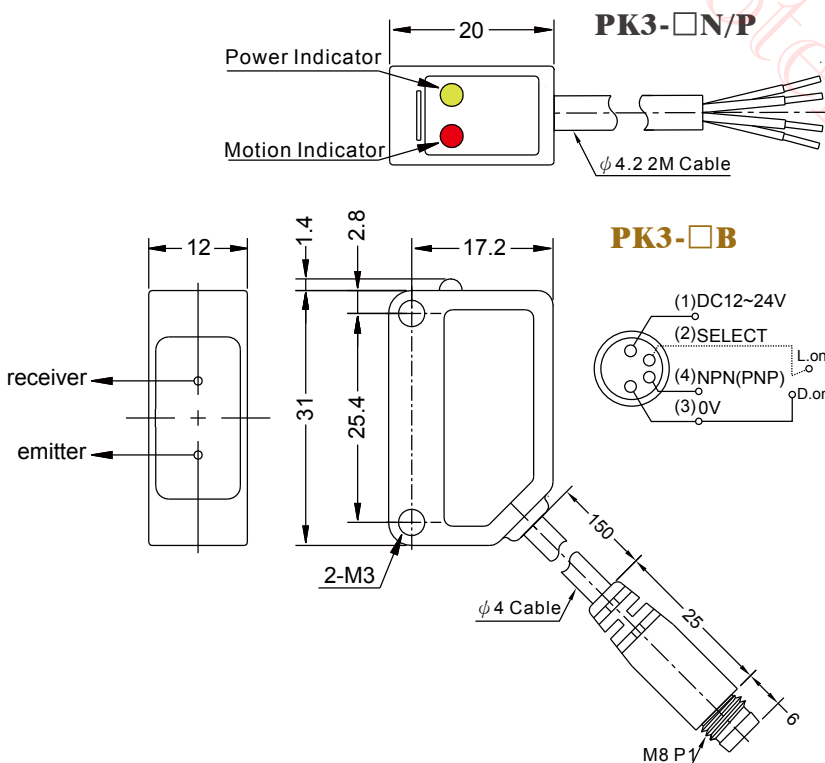

Detecting different raw materials

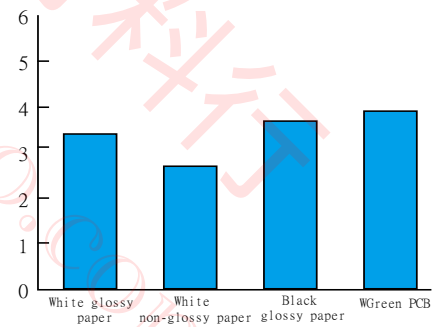

Applications / 應用

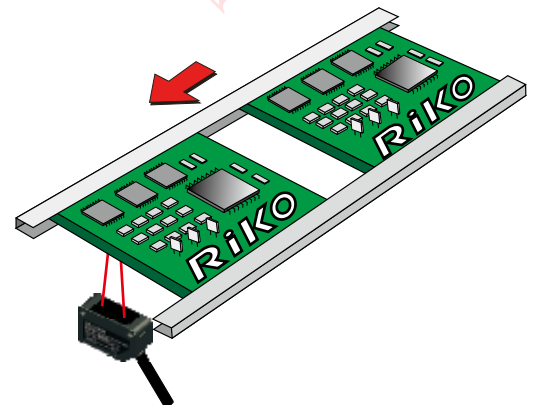

PK3

Rectangular Photo Sensor

◆Introduction / 介紹 :

●Clearly visible red LED (QM series) / 清晰可見的紅光LED(QM系列)

The visible red LED is available at the distance of 10cm for PK3-QM□. It is easy for your installation and detection.

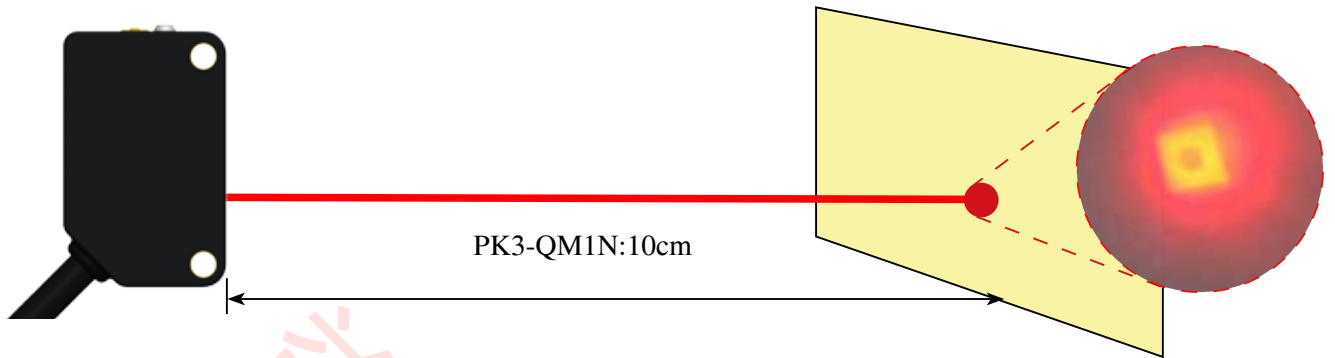

●Dual LED indicator / 雙LED指示燈

Visible dual LED makes you easy to know the current operating situation.

●Non-spherical optical lens / 非球面光學鏡片

For a better focusing, with the exceptional optical lens.

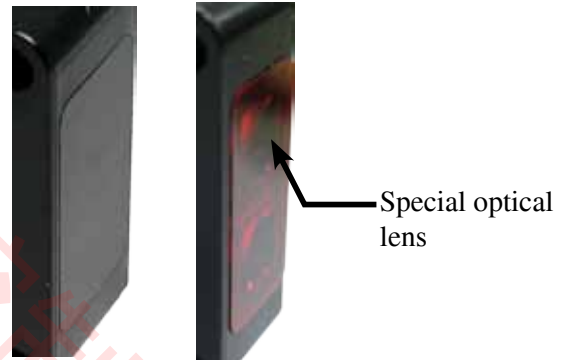

●Flexible Mounting / 本體固定

Embedded brass screw hole, easy mounting and no damage to the body.



◆Application / 應用例 :

Detecting objects with irregular shapes. / 不規則形狀檢出

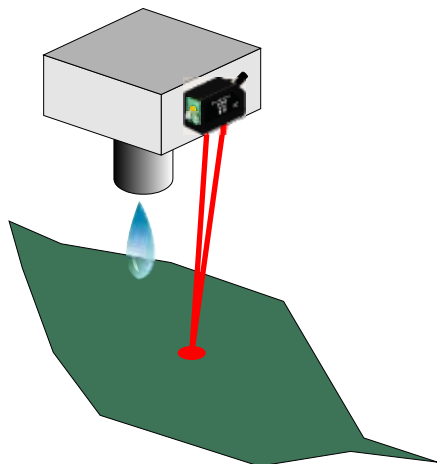

PK3-QM1N

Detecting the lid on the product is existed or not. / 檢測產品有無蓋子

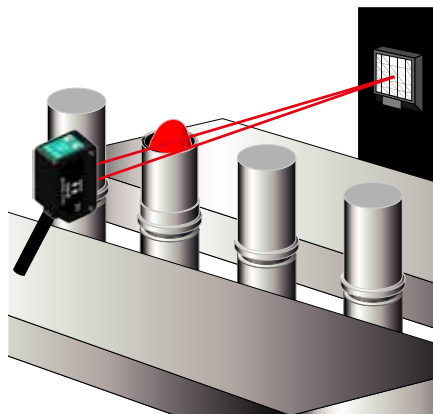

PK3-QM1N

Detecting if the IC is existed or not. / 檢測有無IC

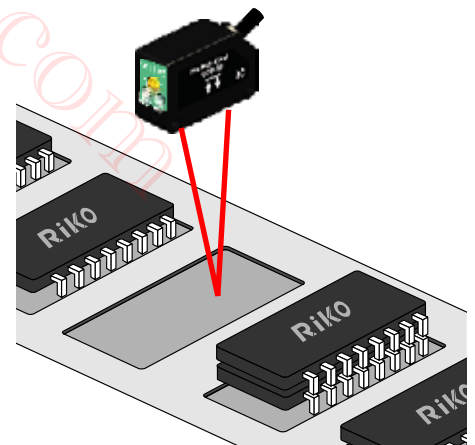

PK3-V03N

Fiber
Photo Sensor
Area Sensor
Ultrasonic Sensors
Inductive Proximity Sensor
Capacitive Proximity Sensor
Timer / Counter
Others
Accessories