

SPR

Micro Photo Sensor

◆Shape / 外觀 :

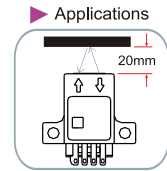
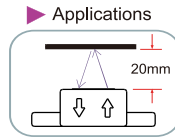

◆Specifications / 規格表 :

| Model / 型號 | SPR-401-N | SPR-401-P | SPR-402-N | SPR-402-P |
|---------------------------------|----------------------------|-----------|---------------|-----------|
| Sensing type / 檢出方式 | Diffuse Reflection / 擴散反射式 | | | |
| Sensing distance / 檢出距離 | 20mm, 黑色泡棉 40x20 | | | |
| Emitting light / 發光源 | Infrared LED 940 nm | | | |
| Operating voltage / 工作電壓 | DC12 ~ 24 V | | | |
| Current Consumption / 消耗電流 | 25 mA Max. | | | |
| Load current / 負載電流 | 100mA Max. at DC24V | | | |
| Output type / 輸出模式 | NPN L.on/D.on | PNP L.on | NPN L.on/D.on | PNP L.on |
| Response time / 反應時間 | 1 ms Max. | | | |
| Insulation resistance / 隔離阻抗 | 20MΩ min. (DC500V) | | | |
| Voltage withstandability / 絕緣耐壓 | AC1000V 60Hz for 60 Sec. | | | |
| Operating temperature/工作溫度 | - 20 °C ~ + 45 °C | | | |
| Ambient humidity / 工作溼度 | 35% ~ 85% RH | | | |
| Material / 外觀材質 | PC | | | |
| Wiring method / 出線方式 | EE1001/EE1006 | | | |
| Weight / 重量 | Approx. 3g | | | |

◆Dimensions/尺寸圖 :

SPR-401-N/P

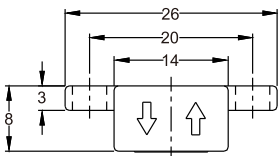

SPR-402-N/P

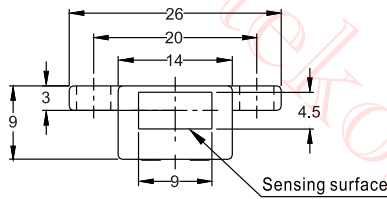

NPN Type

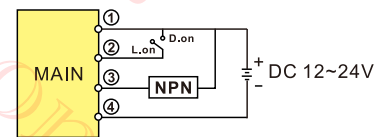
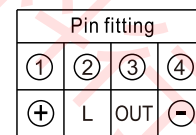

PNP Type

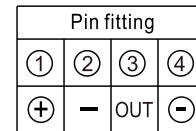

P Type

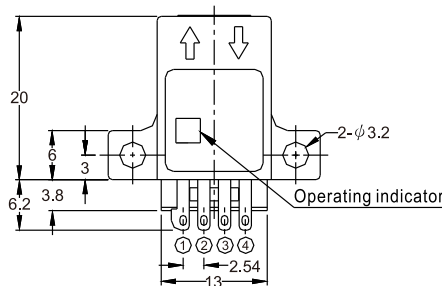
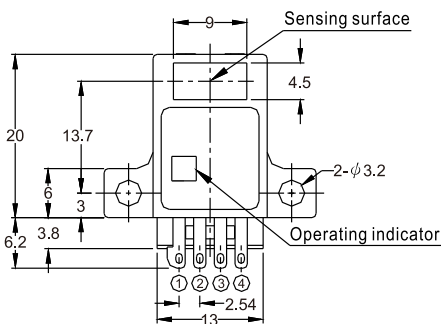
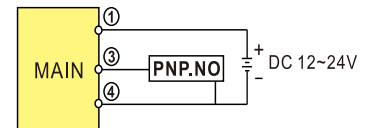



Micro Photo Sensor

◆ Applications / 應用 :

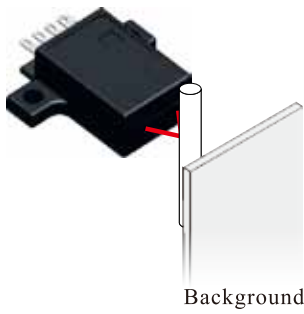

(A) Not affected by the background.

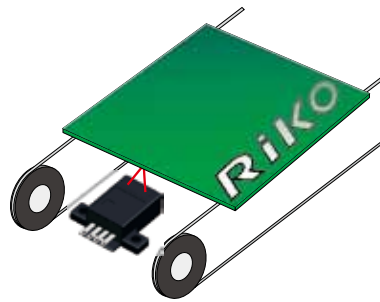

(B) To detect the PCB boards.

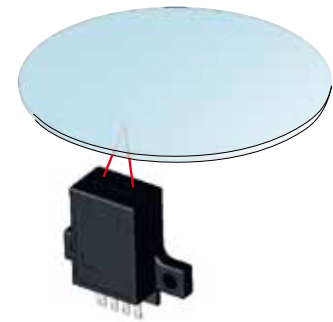

(C) To detect the transparent objects.

◆ Wiring diagrams / 線路圖 :

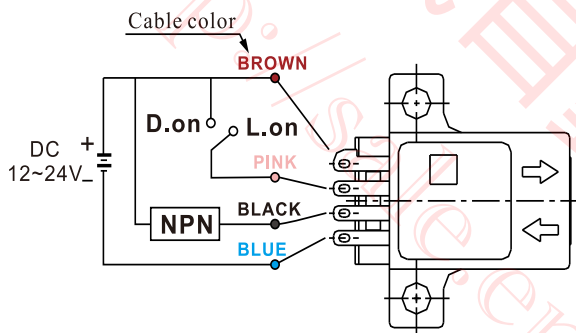

(a) NPN Type

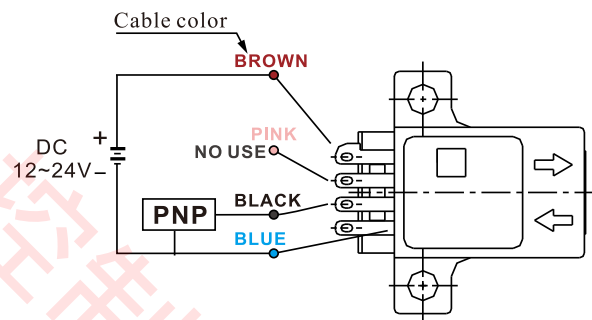

(b) PNP Type

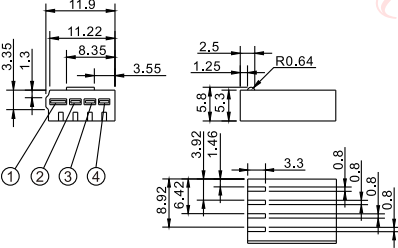
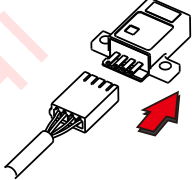

◆ Connectors / 線材 :

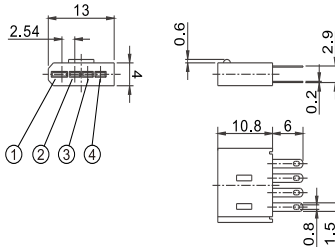
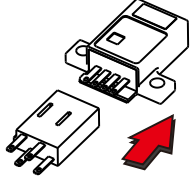
| Model / 產品圖 | Dimensions / 尺寸圖 | Cable Color | Available Model | Operation Instructions |
|--|---|--|-----------------|---|
|  <p>EE-1006</p> |  | 1-BROWN 2-PINK 3-BLACK 4-BLUE | SPR Series |  |
|  <p>EE-1001</p> |  | 1-BROWN 2-PINK 3-BLACK 4-BLUE | SPR Series |  |

Fiber
Photo Sensor
Area Sensor
Ultrasonic Sensors
Inductive Proximity Sensor
Capacitive Proximity Sensor
Timer / Counter
Others
Accessories