

Glass Fibers

Selection Guide

1 ASSEMBLY STYLE

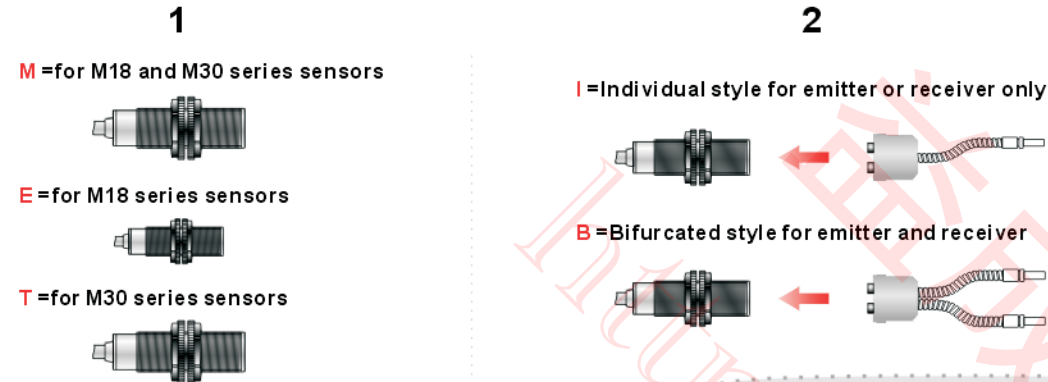

2 SENSING END TIP STYLE

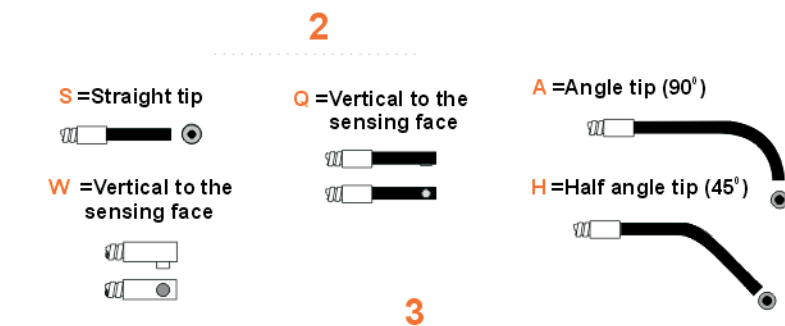
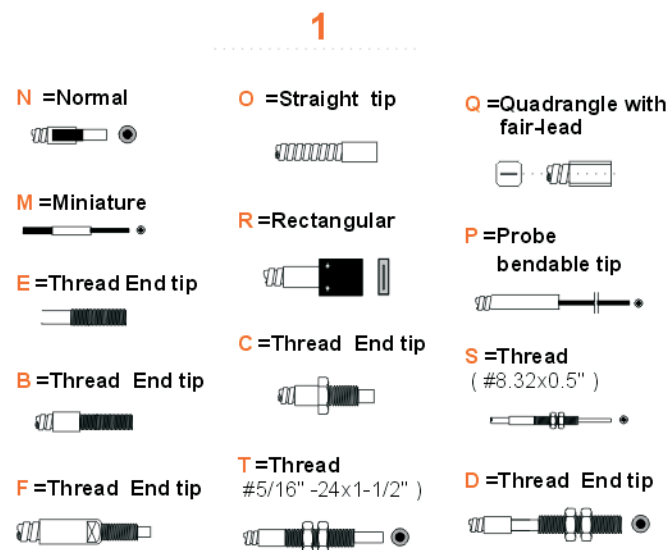

3 BUNDLE DIAMETER OR DIMENSIONS

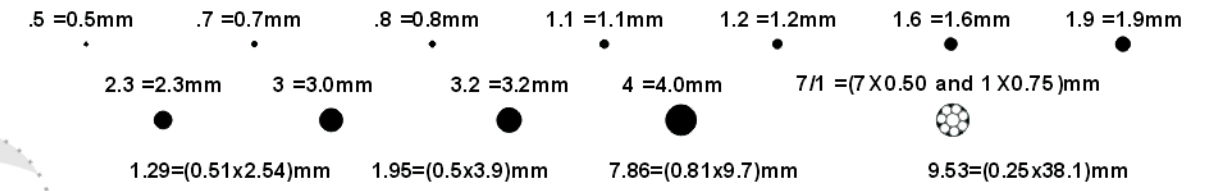

4 FIBRE OVERALL LENGTH

- N = Brass Nickel-Plated (φ4.9 φ5.9 φ8.1)
- C = Brass chromium plated (φ4.0 φ5.0 φ6.0)
- M = Ms verchromt (φ4.0 φ5.0)
- P = PVC with galvanized mono coil reinforcing wire (φ2.1 φ2.3 φ2.5 φ2.9 φ4.0 φ5.3)
- R = PUR with galvanized mono coil reinforcing wire (φ4.5 φ6.0)
- S = Stainless steel (φ4.9 φ5.9 φ6.8 φ8.1)
- W = SS with Silicon (φ5.3 φ7.3)
- L = Chrome-nickel-steel (φ2.0)
- HDP = High density polyethylene (max.electrical isolation,min.Flexibility)
- T = Tefon tubing (max.chemical resistance, min.Flexibility)

5 SHEATHING MATERIA AND DIAMETER

5 = 500mm T = other dimensions

6 MODIFICATIONS

- A0.09 = the length of the ferrule after the angle is 0.09 meter
- AC = for acidic liquid level protection
- ADEN = the sensor end is angled
- B0.027 = the length of the ferrule before the angle is 0.027 meter

- DA = Double-angled, both the sensing end and the sensor end are angled
- F90 = can be used in 900°F environments.
- LP = Liquid Level Probe
- NC = Non-Conductive
- OPP = opposed mode
- SR = Silicone Rubber sheathing for Electrical insulation properties
- V = Vertical, the fibre is vertical to the mesh of light bundle

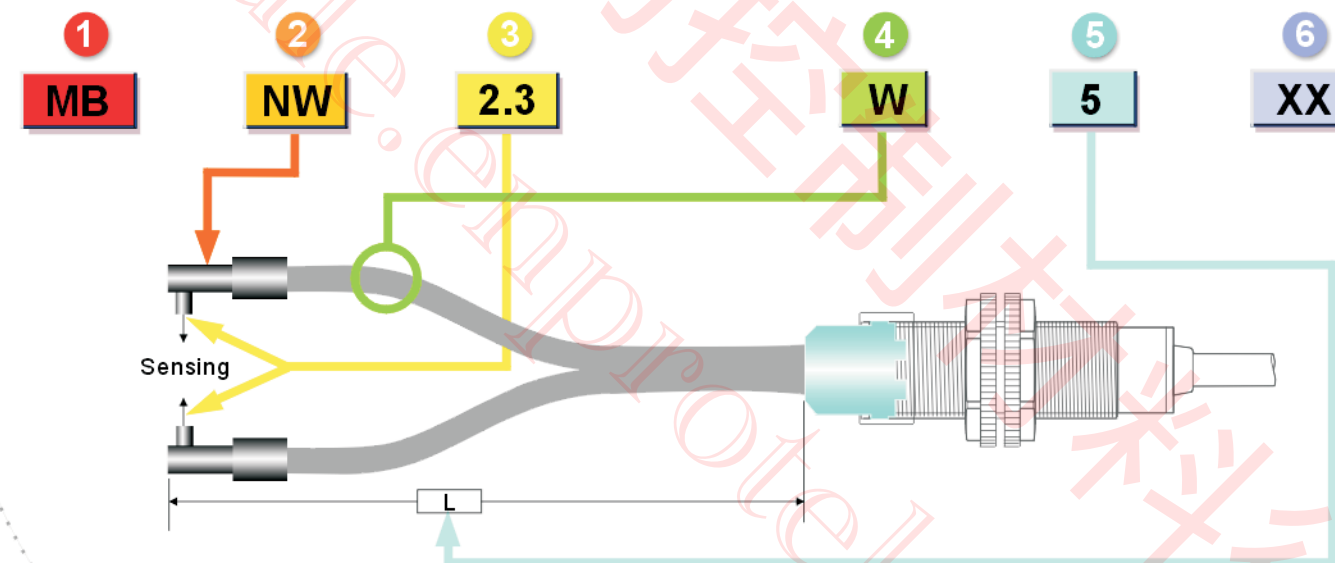

Glass Fibers

Diffuse Mode

Bifurcated Cables



Dimensions (mm)	Model number	Length	Bundle	Sheath	Range (mm)
TBN2.3P	TBN2.3P	500	ϕ 2.3	PVC	

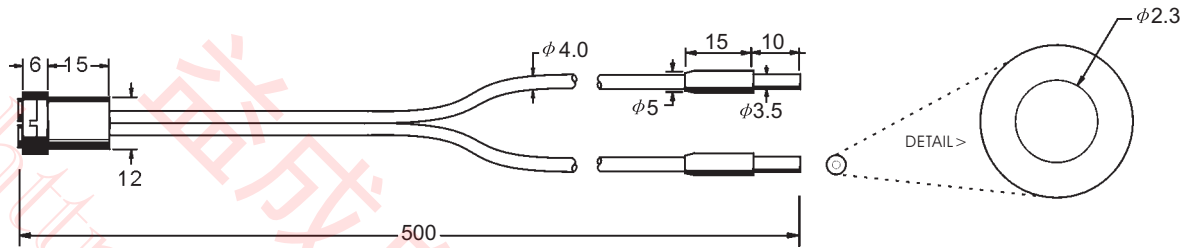

Dimensions (mm)	Model number	Length	Bundle	Sheath	Range (mm)
TBN2.3N	TBN2.3N	500	ϕ 2.3	N	

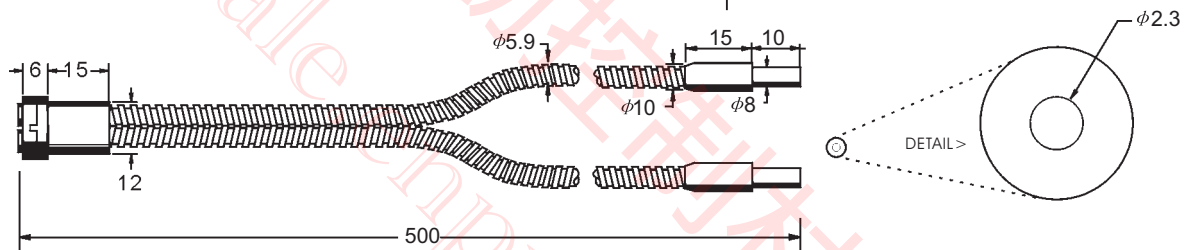

Dimensions (mm)	Model number	Length	Bundle	Sheath	Range (mm)
TBB3N	TBB3N	500	ϕ 3.0	N	

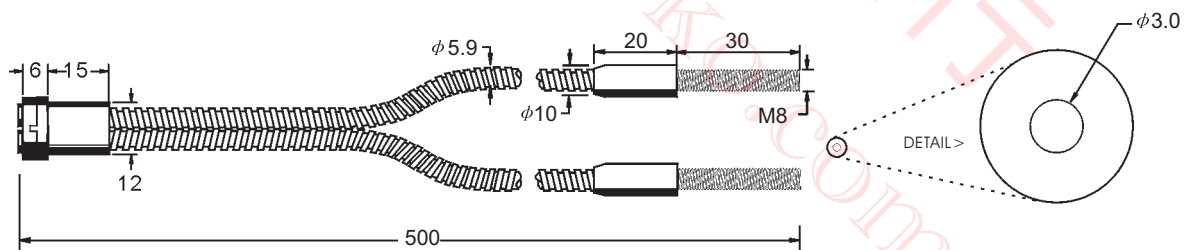

Dimensions (mm)	Model number	Length	Bundle	Sheath	Range (mm)
TBNWN	TBNWN	500	ϕ 0.8	N	

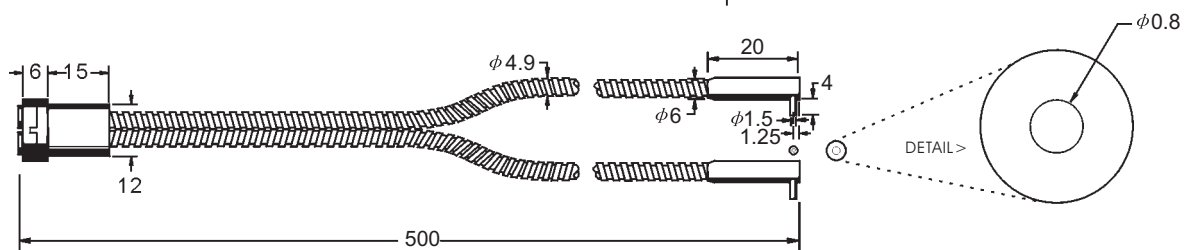

Glass Fibers

Opposed Mode Individual Cables

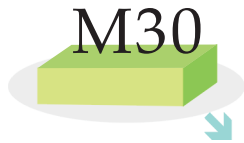

Dimensions (mm)	Model number	Length	Bundle	Sheath	Range (mm)
-----------------	--------------	--------	--------	--------	------------

TBNW2.3N

TBNW2.3N	500	ϕ 2.3	N	
----------	-----	------------	---	--

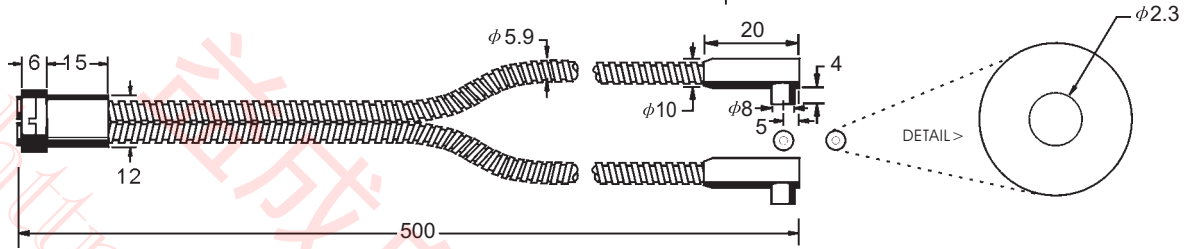

Dimensions (mm)	Model number	Length	Bundle	Sheath	Range (mm)
-----------------	--------------	--------	--------	--------	------------

TBNW3N

TBNW3N	500	ϕ 3.0	N	
--------	-----	------------	---	--

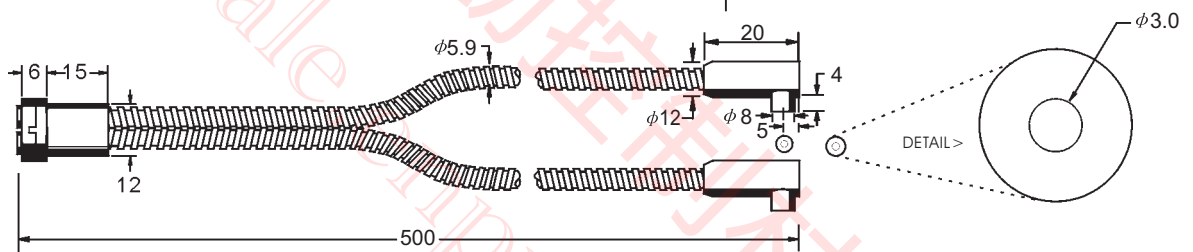

Dimensions (mm)	Model number	Length	Bundle	Sheath	Range (mm)
-----------------	--------------	--------	--------	--------	------------

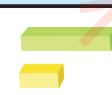

Dimensions (mm)	Model number	Length	Bundle	Sheath	Range (mm)
-----------------	--------------	--------	--------	--------	------------



Glass Fibers

Diffuse Mode Bifurcated Cables



Dimensions (mm)	Model number	Length	Bundle	Sheath	Range (mm)
-----------------	--------------	--------	--------	--------	------------

MIN1.9W

MIN1.9W	500	ϕ 1.9	W
---------	-----	------------	---

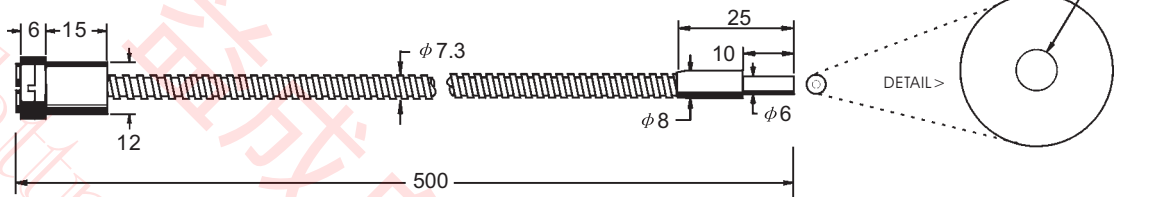

Dimensions (mm)	Model number	Length	Bundle	Sheath	Range (mm)
-----------------	--------------	--------	--------	--------	------------

MINW1.9W

MINW1.9W	500	ϕ 1.9	W
----------	-----	------------	---

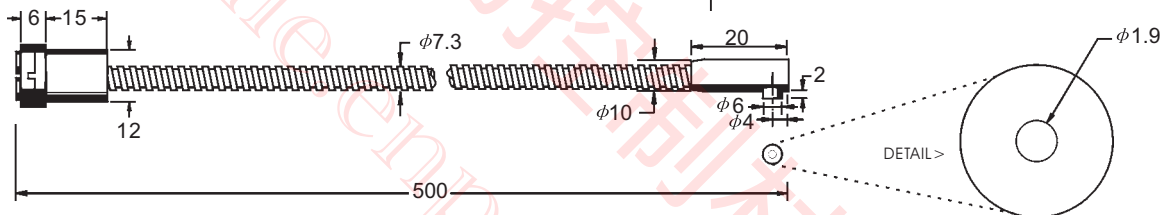

Dimensions (mm)	Model number	Length	Bundle	Sheath	Range (mm)
-----------------	--------------	--------	--------	--------	------------

MINW1.1N

MINW1.1N	500	ϕ 1.1	N
----------	-----	------------	---

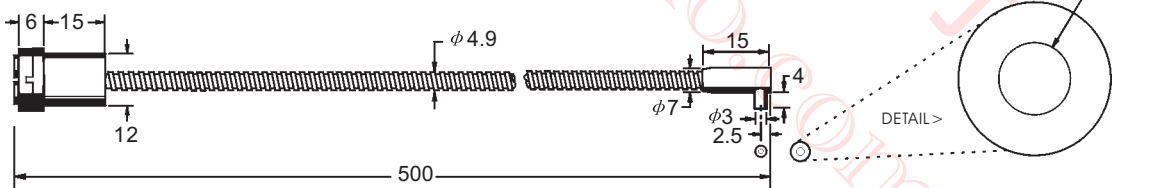

Dimensions (mm)	Model number	Length	Bundle	Sheath	Range (mm)
-----------------	--------------	--------	--------	--------	------------

MINW2.3N

MINW2.3N	500	ϕ 2.3	N
----------	-----	------------	---

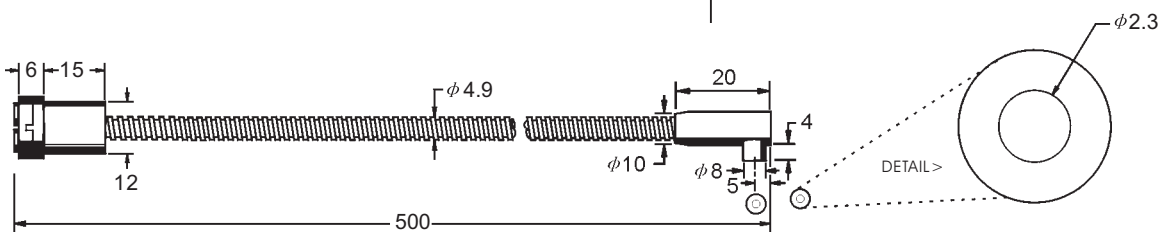

Glass Fibers

Diffuse Mode Bifurcated Cables



Dimensions (mm)	Model number	Length	Bundle	Sheath	Range (mm)
MINA1.6S	MINA1.6P	500	ϕ 1.6	PVC	
	MINA1.6S	500	ϕ 1.6	SS	

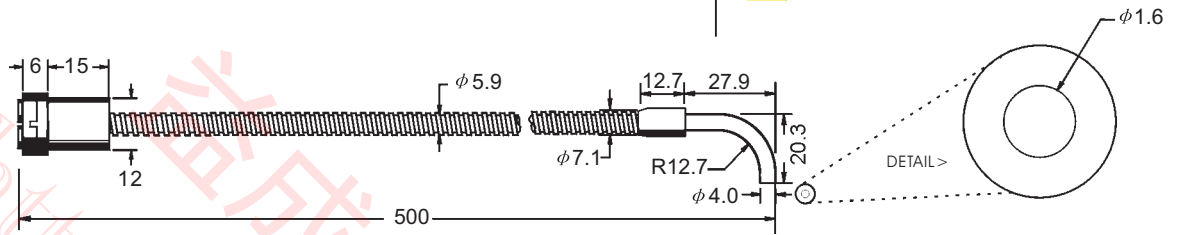

Dimensions (mm)	Model number	Length	Bundle	Sheath	Range (mm)
MINA3.2S	MINA3.2P	500	ϕ 3.2	PVC	
	MINA3.2S	500	ϕ 3.2	SS	

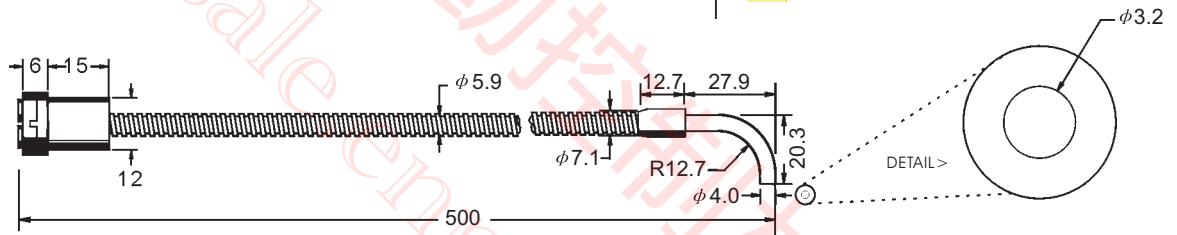

Dimensions (mm)	Model number	Length	Bundle	Sheath	Range (mm)
MINA4S	MINA4P	500	ϕ 4.0	PVC	
	MINA4S	500	ϕ 4.0	SS	

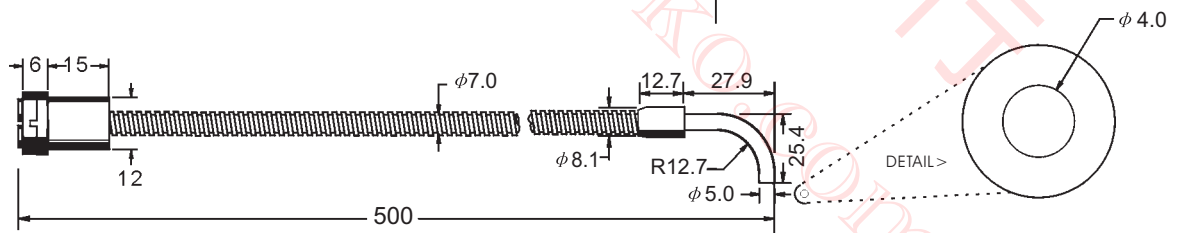

Dimensions (mm)	Model number	Length	Bundle	Sheath	Range (mm)
MINAE1.29S	MINAE1.29P	500	0.51x2.54	PVC	
	MINAE1.29S	500	0.51x2.54	SS	

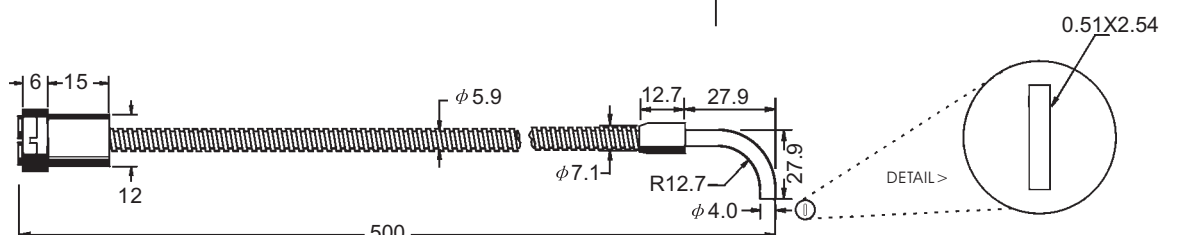

Diffuse Mode Bifurcated Cables

Glass Fibers



Dimensions (mm)	Model number	Length	Bundle	Sheath	Range (mm)
MINAR1.29S	MINAR1.29P	500	0.51x2.54	PVC	
	MINAR1.29S	500	0.51x2.54	SS	

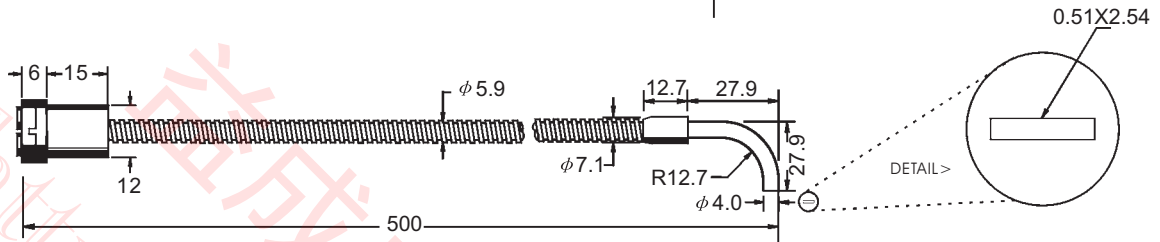

Dimensions (mm)	Model number	Length	Bundle	Sheath	Range (mm)
MINAM1.2S	MINAM1.2P	500	ϕ 1.2	PVC	
	MINAM1.2S	500	ϕ 1.2	SS	

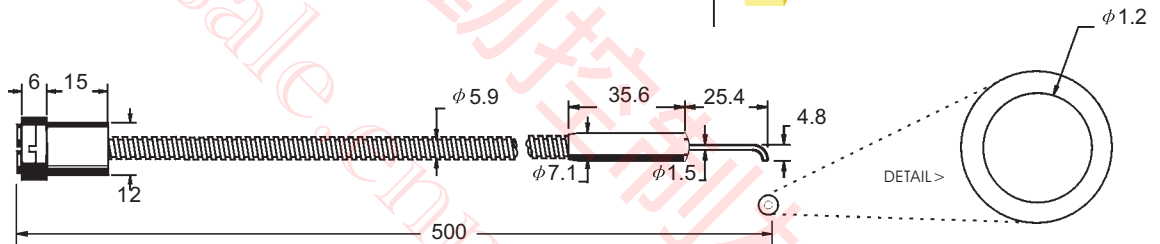

Dimensions (mm)	Model number	Length	Bundle	Sheath	Range (mm)
MINAI.7S	MINAI.7P	500	ϕ 0.7	PVC	
	MINAI.7S	500	ϕ 0.7	SS	

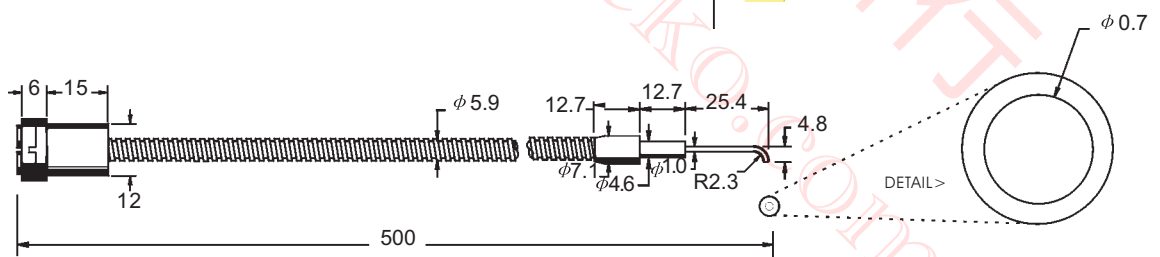

Dimensions (mm)	Model number	Length	Bundle	Sheath	Range (mm)
MINH1.6S	MINH1.6P	500	ϕ 1.6	PVC	
	MINH1.6S	500	ϕ 1.6	SS	

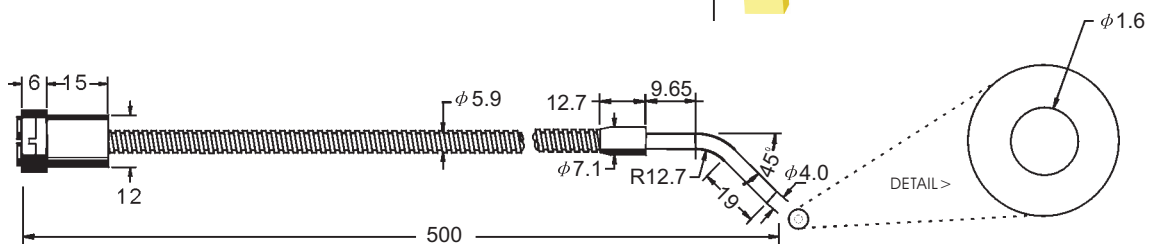

Glass Fibers

Diffuse Mode Bifurcated Cables



Dimensions (mm)	Model number	Length	Bundle	Sheath	Range (mm)
MINH3.2S	MINH3.2P	500	φ 3.2	PVC	
	MINH3.2S	500	φ 3.2	SS	

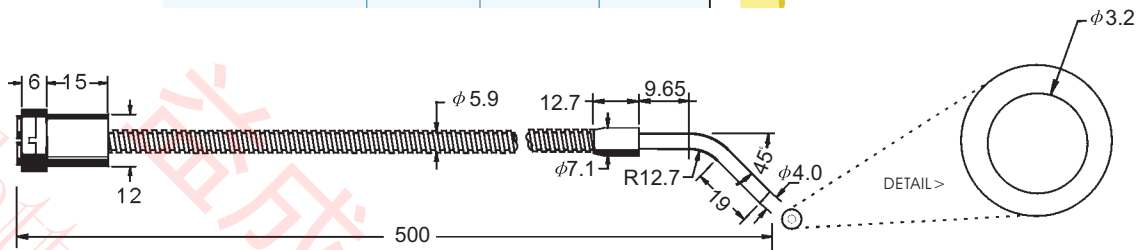

Dimensions (mm)	Model number	Length	Bundle	Sheath	Range (mm)
MINH4S	MINH4P	500	φ 4.0	PVC	
	MINH4S	500	φ 4.0	SS	

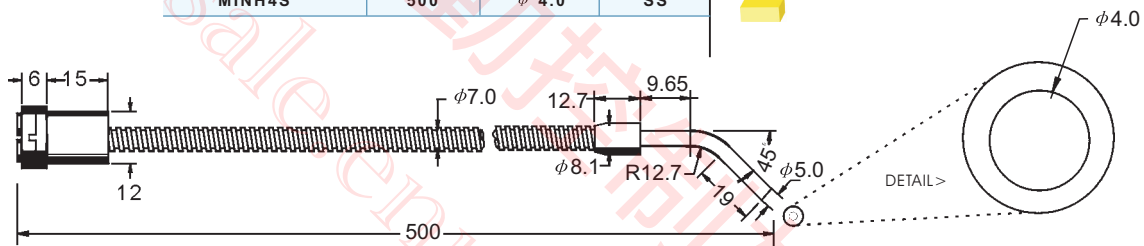

Dimensions (mm)	Model number	Length	Bundle	Sheath	Range (mm)
MINHE1.29S	MINHE1.29P	500	0.51x2.54	PVC	
	MINHE1.29S	500	0.51x2.54	SS	

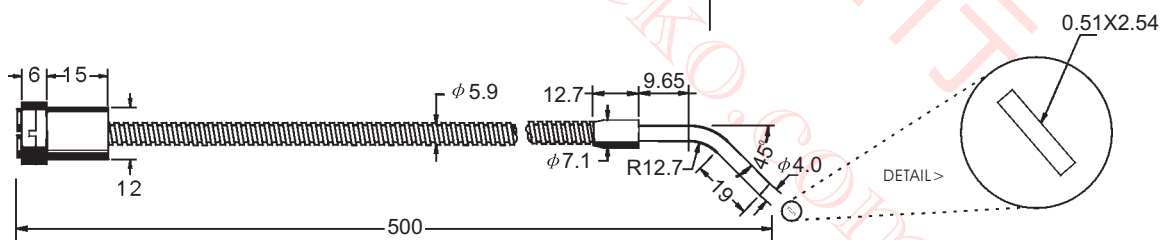

Dimensions (mm)	Model number	Length	Bundle	Sheath	Range (mm)
MINHR1.29S	MINHR1.29P	500	0.51x2.54	PVC	
	MINHR1.29S	500	0.51x2.54	SS	

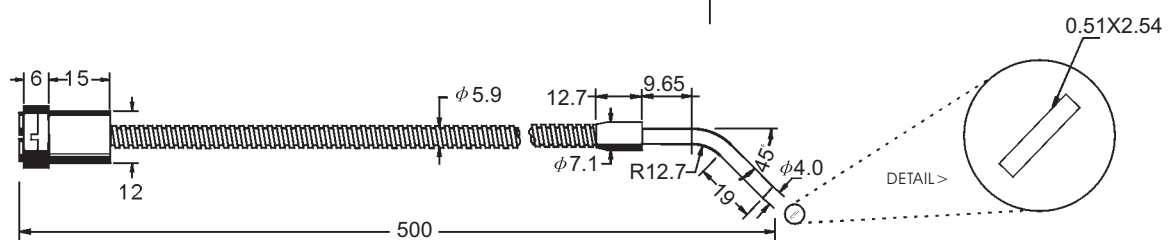

Glass Fibers

Diffuse Mode

Bifurcated Cables



Dimensions (mm)	Model number	Length	Bundle	Sheath	Range (mm)
MIN1.6S	MIN1.6P	500	ϕ 1.6	PVC	
	MIN1.6S	500	ϕ 1.6	SS	

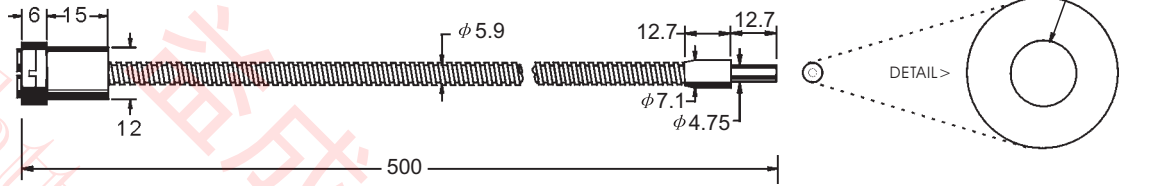

Dimensions (mm)	Model number	Length	Bundle	Sheath	Range (mm)
MIN3.2S	MIN3.2P	500	ϕ 3.2	PVC	
	MIN3.2S	500	ϕ 3.2	SS	

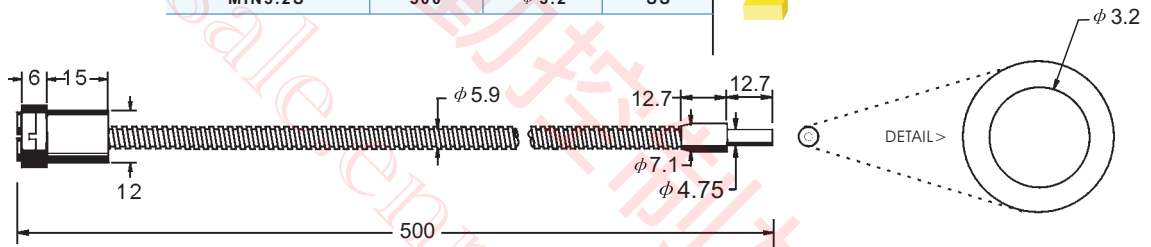

Dimensions (mm)	Model number	Length	Bundle	Sheath	Range (mm)
MIN4S	MIN4P	500	ϕ 4.0	PVC	
	MIN4S	500	ϕ 4.0	SS	

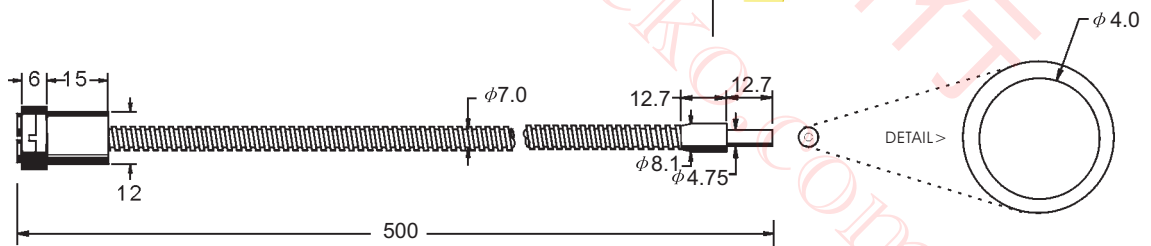

Dimensions (mm)	Model number	Length	Bundle	Sheath	Range (mm)
MINSM1.2S	MINSM1.2S	500	ϕ 1.2	SS	

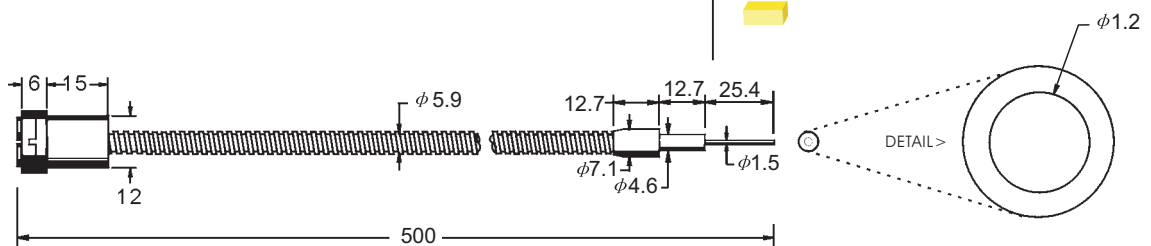

Glass Fibers

Diffuse Mode Bifurcated Cables



Dimensions (mm)	Model number	Length	Bundle	Sheath	Range (mm)
-----------------	--------------	--------	--------	--------	------------

MINSM.7S

MINSM.7S	500	ϕ 0.7	SS
----------	-----	------------	----

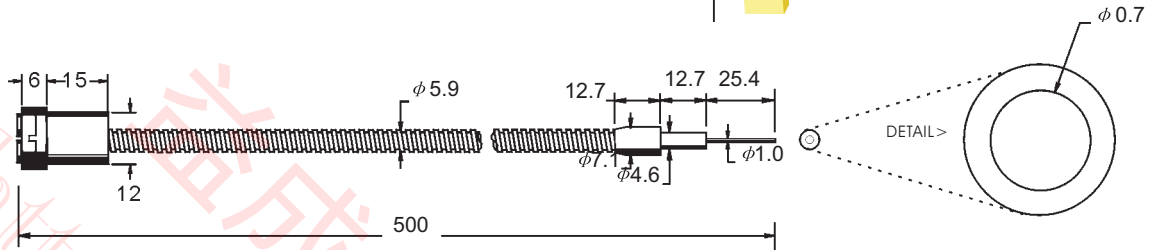

Dimensions (mm)	Model number	Length	Bundle	Sheath	Range (mm)
-----------------	--------------	--------	--------	--------	------------

MINSE1.29S

MINSE1.29P	500	0.51x2.54	PVC
MINSE1.29S	500	0.51x2.54	SS

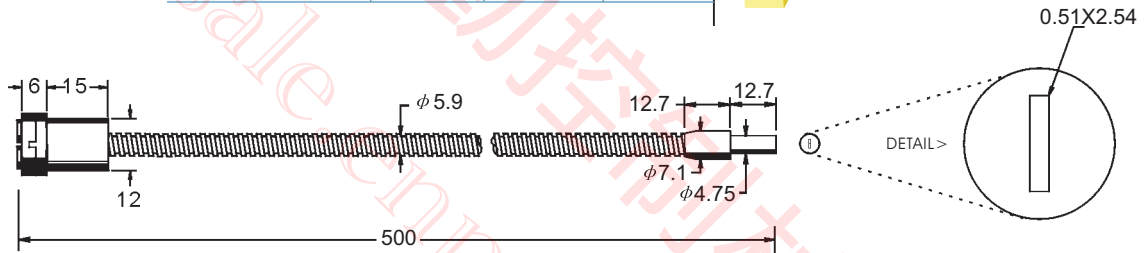

Dimensions (mm)	Model number	Length	Bundle	Sheath	Range (mm)
-----------------	--------------	--------	--------	--------	------------

MINQ1.2C

MINQ1.2P	500	ϕ 1.2	PVC
MINQ1.2S	500	ϕ 1.2	SS

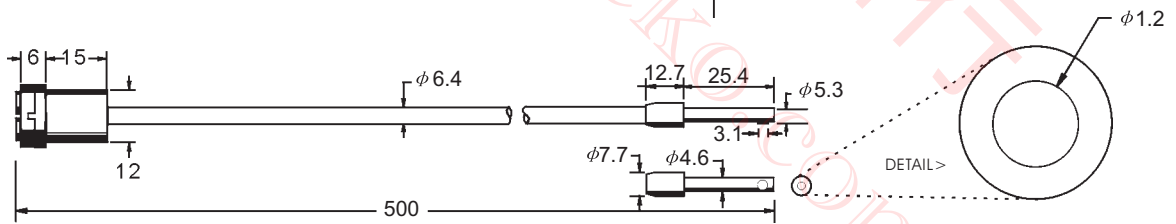

Dimensions (mm)	Model number	Length	Bundle	Sheath	Range (mm)
-----------------	--------------	--------	--------	--------	------------

MINQ1.6S

MINQ1.6P	500	ϕ 1.6	PVC
MINQ1.6S	500	ϕ 1.6	SS

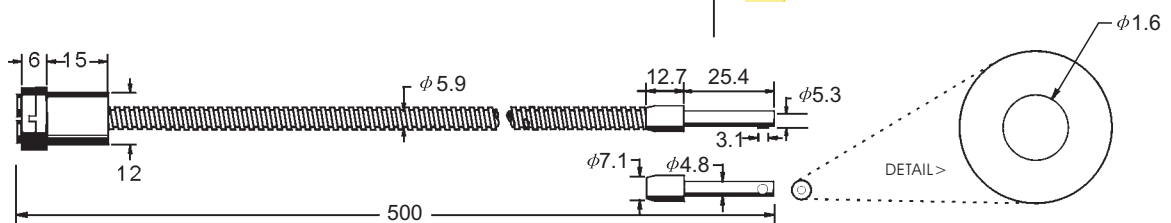

Glass Fibers

Diffuse Mode

Bifurcated Cables



Dimensions (mm)	Model number	Length	Bundle	Sheath	Range (mm)
MINQ2.3S	MINQ2.3P	500	φ 2.3	PVC	
	MINQ2.3S	500	φ 2.3	SS	

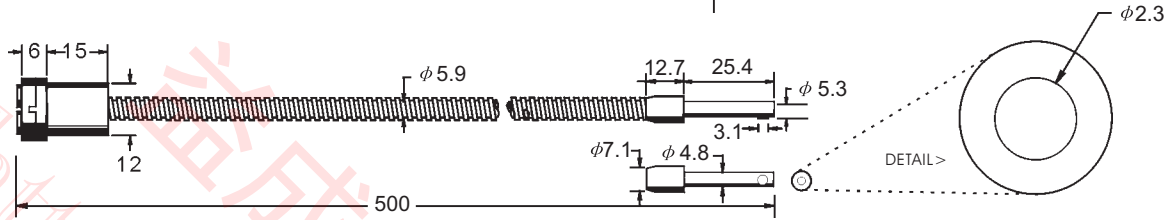

Dimensions (mm)	Model number	Length	Bundle	Sheath	Range (mm)
MIOSR1.29S	MIOSR1.29P	500	0.51x2.54	PVC	
	MIOSR1.29S	500	0.51x2.54	SS	

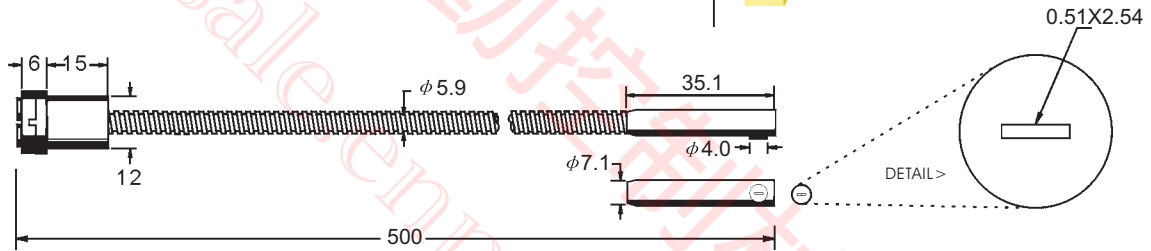

Dimensions (mm)	Model number	Length	Bundle	Sheath	Range (mm)
MITA1.6S	MITA1.6P	500	φ 1.6	PVC	
	MITA1.6S	500	φ 1.6	SS	

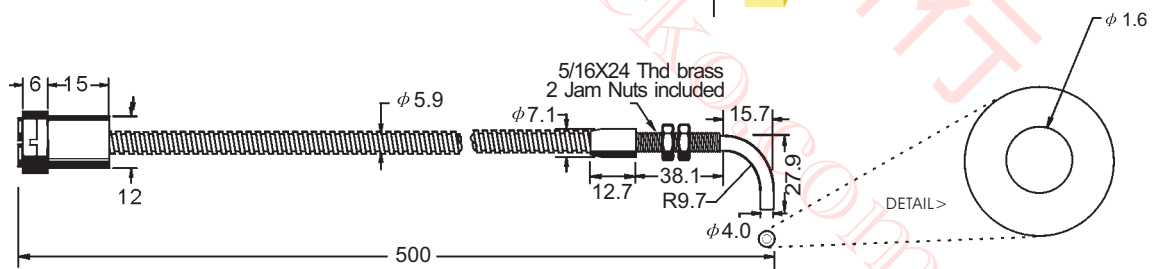

Dimensions (mm)	Model number	Length	Bundle	Sheath	Range (mm)
MITA3.2S	MITA3.2P	500	φ 3.2	PVC	
	MITA3.2S	500	φ 3.2	SS	

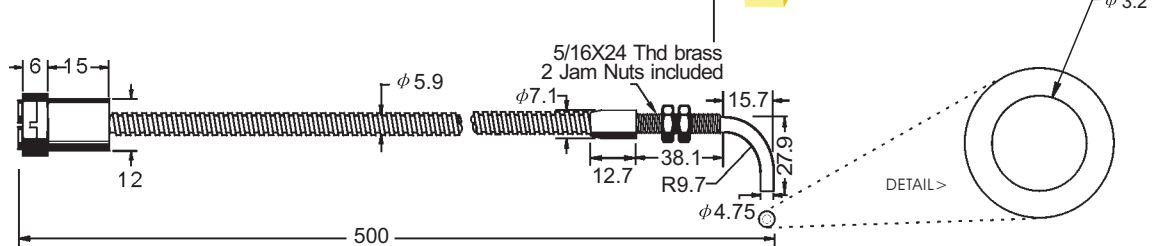

Glass Fibers

Diffuse Mode Bifurcated Cables

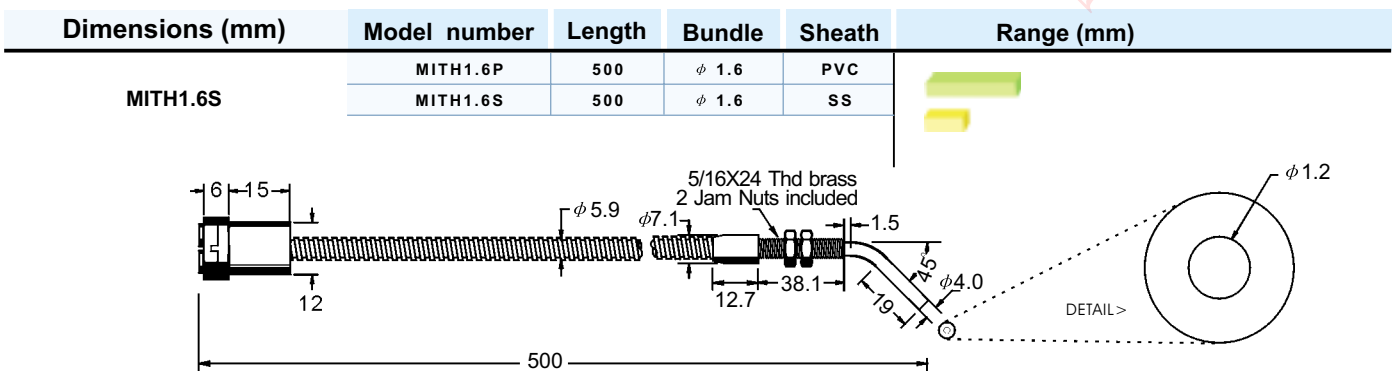
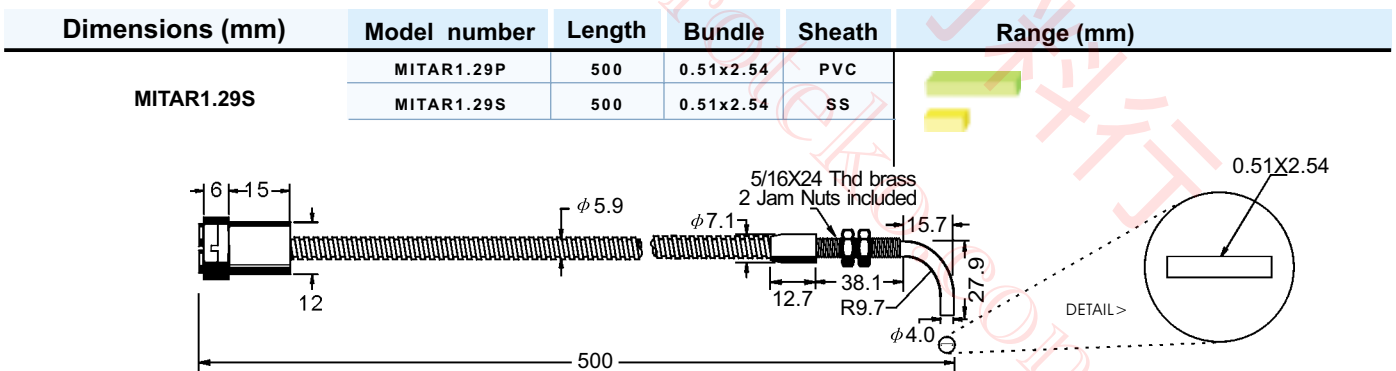
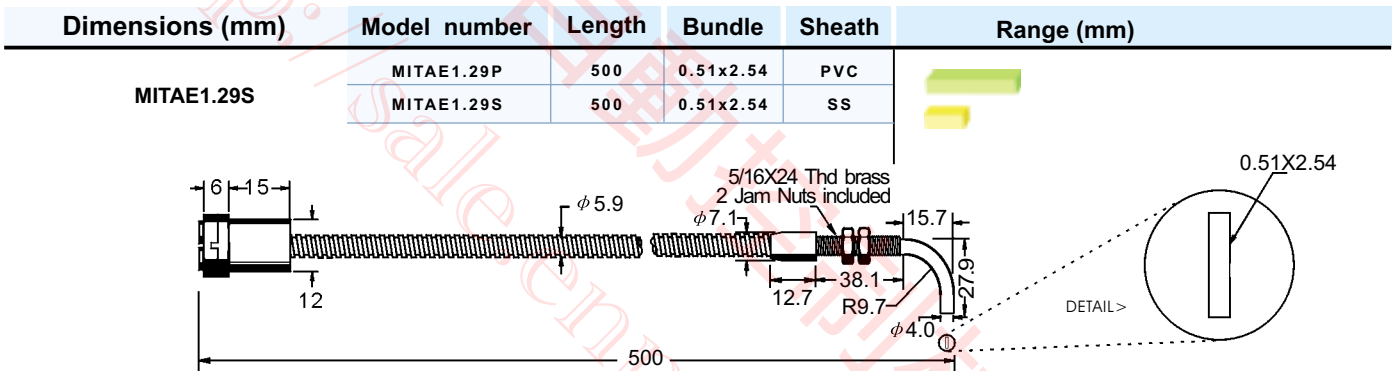
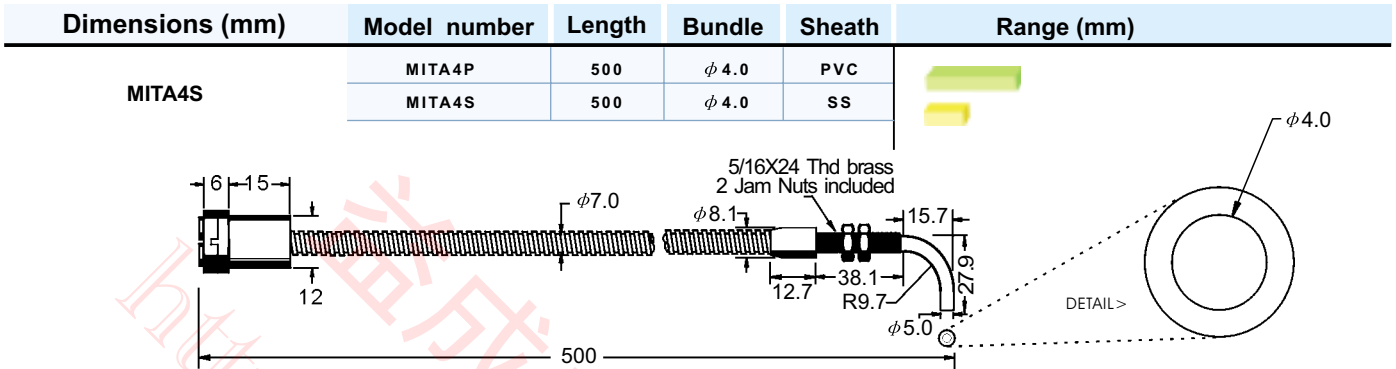

Glass Fibers

Diffuse Mode

Bifurcated Cables



Dimensions (mm)	Model number	Length	Bundle	Sheath	Range (mm)
MITH3.2S	MITH3.2C	500	ϕ 3.2	PVC	
	MITH3.2S	500	ϕ 3.2	SS	

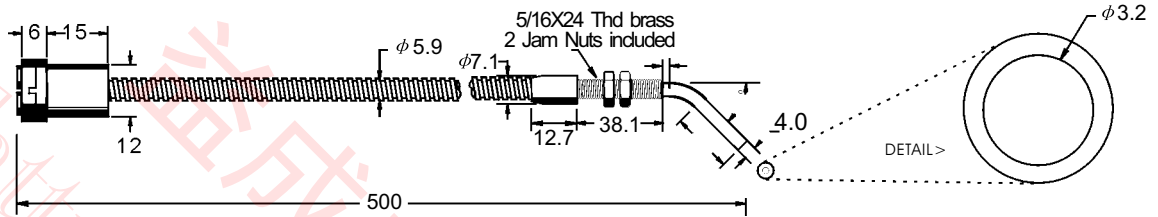

Dimensions (mm)	Model number	Length	Bundle	Sheath	Range (mm)
MITH4S	MITH4C	500	ϕ 4.0	PVC	
	MITH4S	500	ϕ 4.0	SS	

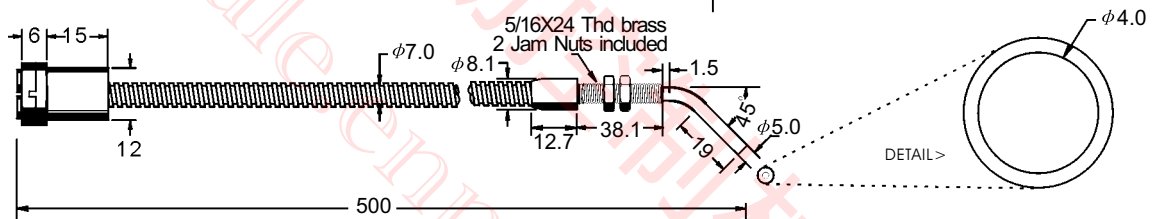

Dimensions (mm)	Model number	Length	Bundle	Sheath	Range (mm)
MITHE1.29S	MITHE1.29P	500	0.51x2.54	PVC	
	MITHE1.29S	500	0.51x2.54	SS	

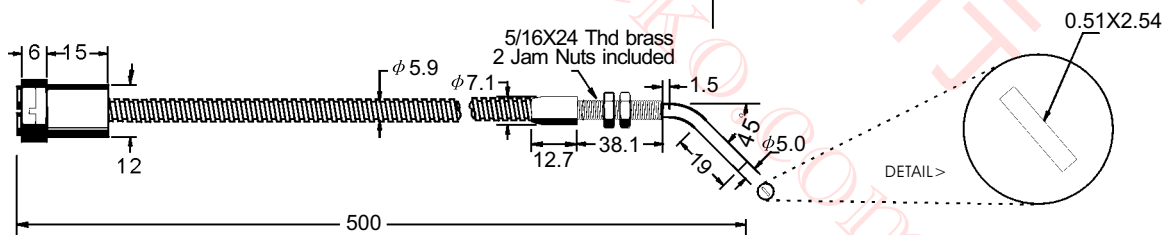

Dimensions (mm)	Model number	Length	Bundle	Sheath	Range (mm)
MITHR1.29S	MITHR1.29P	500	0.51x2.54	PVC	
	MITHR1.29S	500	0.51x2.54	SS	

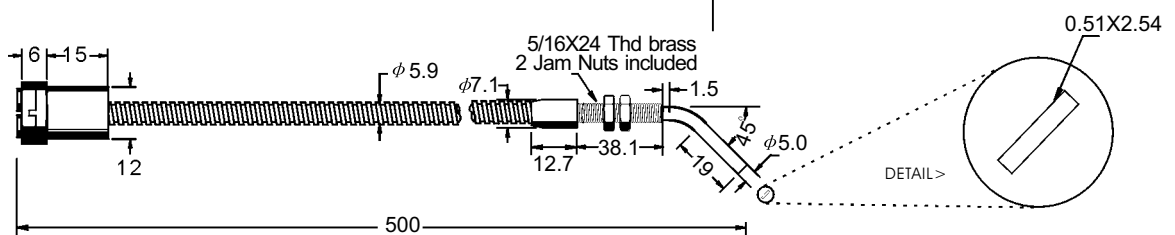

Glass Fibers

Diffuse Mode Bifurcated Cables



Dimensions (mm)	Model number	Length	Bundle	Sheath	Range (mm)
MITS1.2C	MITS1.2P	500	ϕ 1.2	PVC	
	MITS1.2S	500	ϕ 1.2	SS	

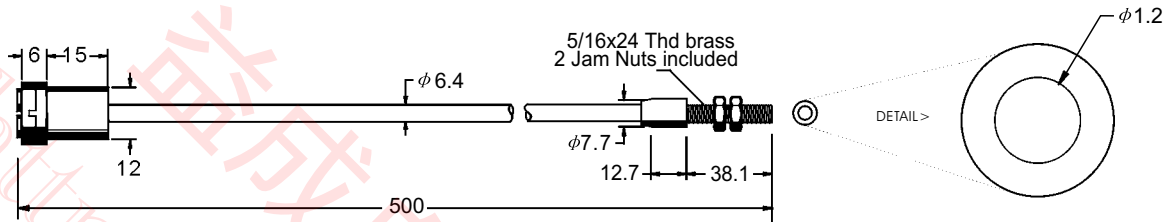

Dimensions (mm)	Model number	Length	Bundle	Sheath	Range (mm)
MITS1.6S	MITS1.6P	500	ϕ 1.6	PVC	
	MITS1.6S	500	ϕ 1.6	SS	

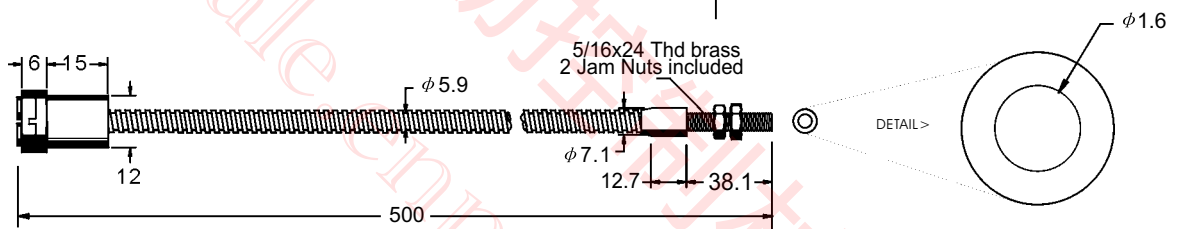

Dimensions (mm)	Model number	Length	Bundle	Sheath	Range (mm)
MITS3.2S	MITS3.2P	500	ϕ 3.2	PVC	
	MITS3.2S	500	ϕ 3.2	SS	

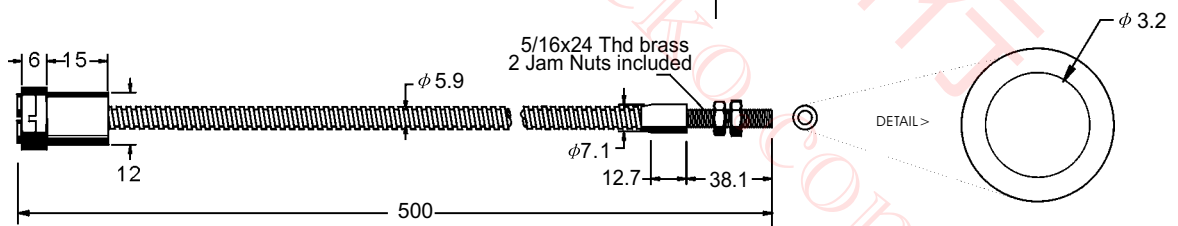

Dimensions (mm)	Model number	Length	Bundle	Sheath	Range (mm)
MITS4S	MITS4P	500	ϕ 4.0	PVC	
	MITS4S	500	ϕ 4.0	SS	

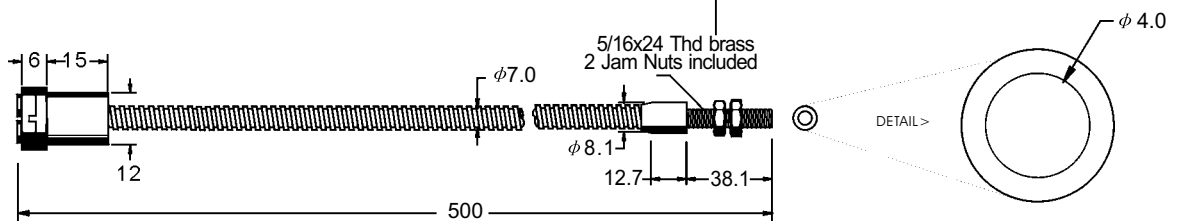

Diffuse Mode

Glass Fibers

Bifurcated Cables



Dimensions (mm)	Model number	Length	Bundle	Sheath	Range (mm)
-----------------	--------------	--------	--------	--------	------------

MITQ1.2S

MITQ1.2S	500	ϕ 1.2	SS
----------	-----	------------	----

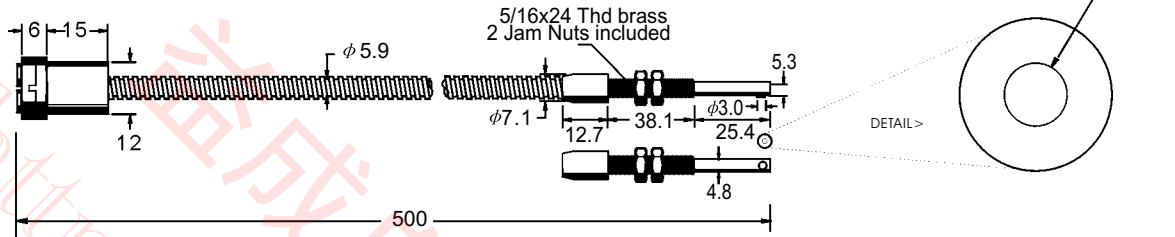

Dimensions (mm)	Model number	Length	Bundle	Sheath	Range (mm)
-----------------	--------------	--------	--------	--------	------------

MITQ2.3S

MITQ2.3S	500	ϕ 2.3	SS
----------	-----	------------	----

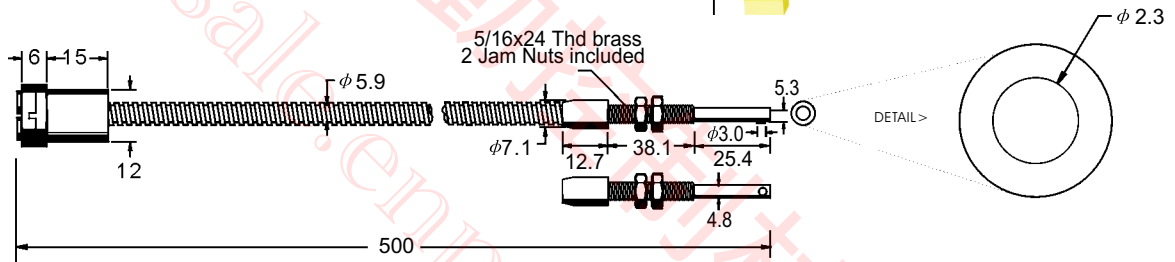

Dimensions (mm)	Model number	Length	Bundle	Sheath	Range (mm)
-----------------	--------------	--------	--------	--------	------------

MIDA1.6S

MIDA1.6P	500	ϕ 1.6	PVC
MIDA1.6S	500	ϕ 1.6	SS

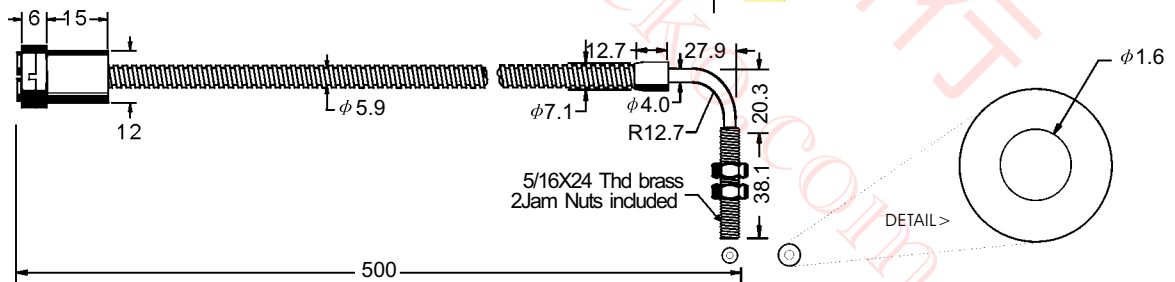

Dimensions (mm)	Model number	Length	Bundle	Sheath	Range (mm)
-----------------	--------------	--------	--------	--------	------------

MIDA3.2S

MIDA3.2P	500	ϕ 3.2	PVC
MIDA3.2S	500	ϕ 3.2	SS

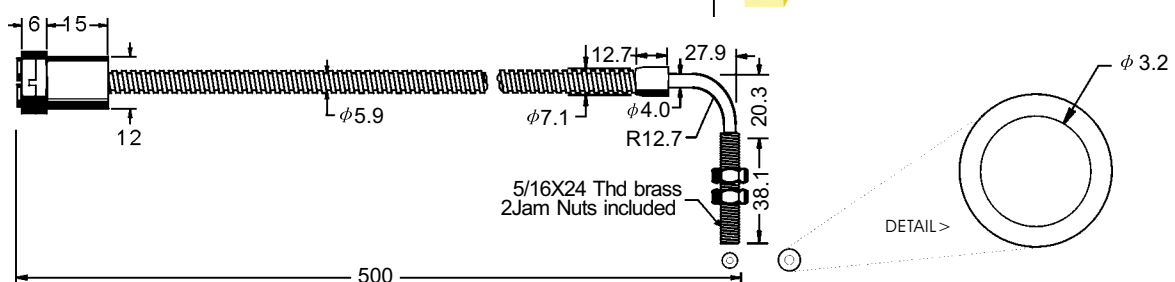

Glass Fibers

Diffuse Mode Bifurcated Cables



Dimensions (mm)	Model number	Length	Bundle	Sheath	Range (mm)
MIDA4S	MIDA4P	500	ϕ 4.0	PVC	
	MIDA4S	500	ϕ 4.0	SS	

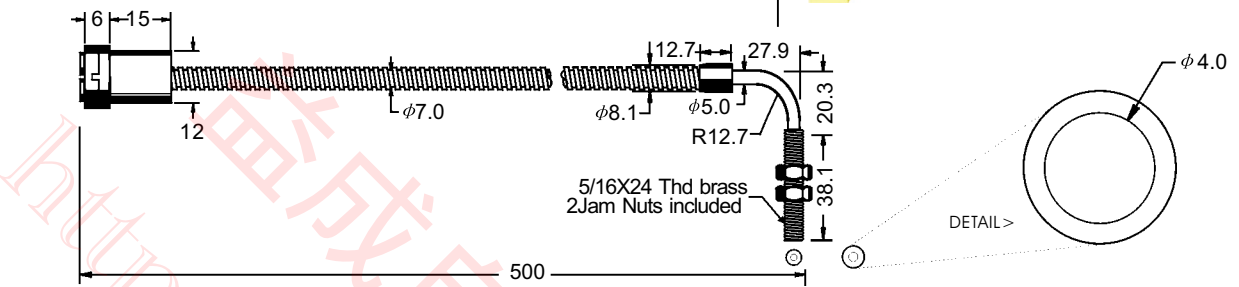

Dimensions (mm)	Model number	Length	Bundle	Sheath	Range (mm)
MIDAE1.29S	MIDAE1.29P	500	0.51x2.54	PVC	
	MIDAE1.29S	500	0.51x2.54	SS	

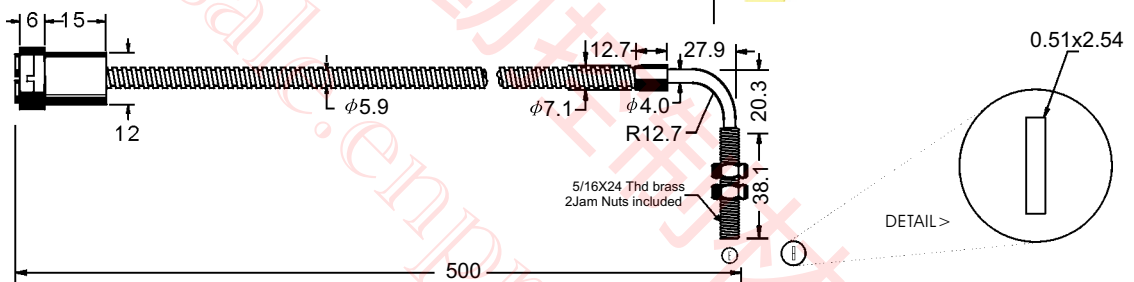

Dimensions (mm)	Model number	Length	Bundle	Sheath	Range (mm)
MIDAR1.29S	MIDAR1.29P	500	0.51x2.54	PVC	
	MIDAR1.29S	500	0.51x2.54	SS	

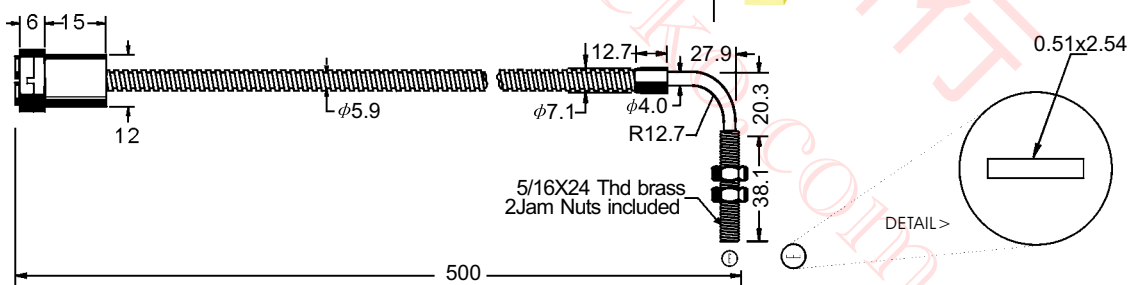

Dimensions (mm)	Model number	Length	Bundle	Sheath	Range (mm)
MIDH1.6S	MIDH1.6P	500	ϕ 1.6	PVC	
	MIDH1.6S	500	ϕ 1.6	SS	

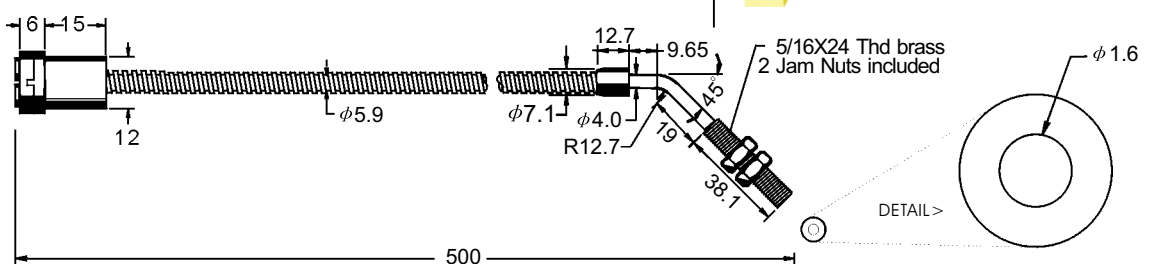

Glass Fibers

Diffuse Mode

Bifurcated Cables



Dimensions (mm)	Model number	Length	Bundle	Sheath	Range (mm)
MIDH3.2S	MIDH3.2P	500	ϕ 3.2	PVC	
	MIDH3.2S	500	ϕ 3.2	SS	

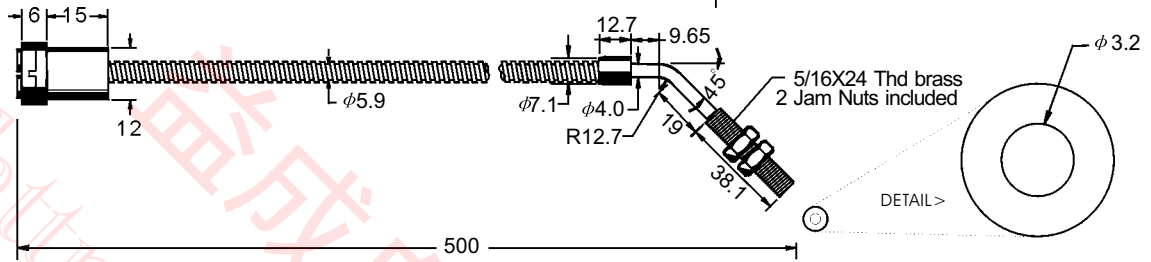

Dimensions (mm)	Model number	Length	Bundle	Sheath	Range (mm)
MIDH4S	MIDH4P	500	ϕ 4.0	PVC	
	MIDH4S	500	ϕ 4.0	SS	

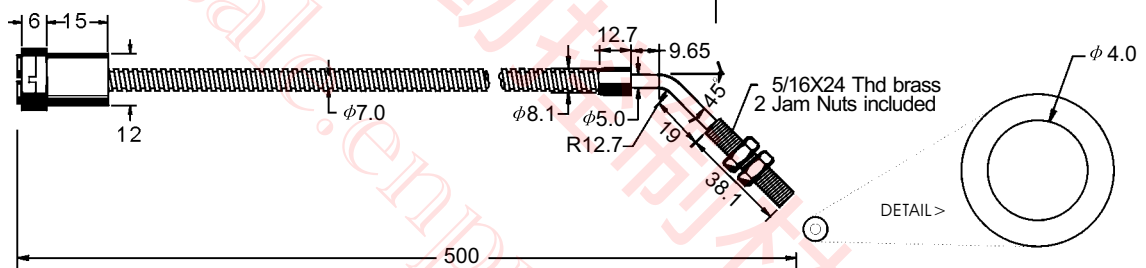

Dimensions (mm)	Model number	Length	Bundle	Sheath	Range (mm)
MIDHE1.29S	MIDHE1.29P	500	0.51x2.54	PVC	
	MIDHE1.29S	500	0.51x2.54	SS	

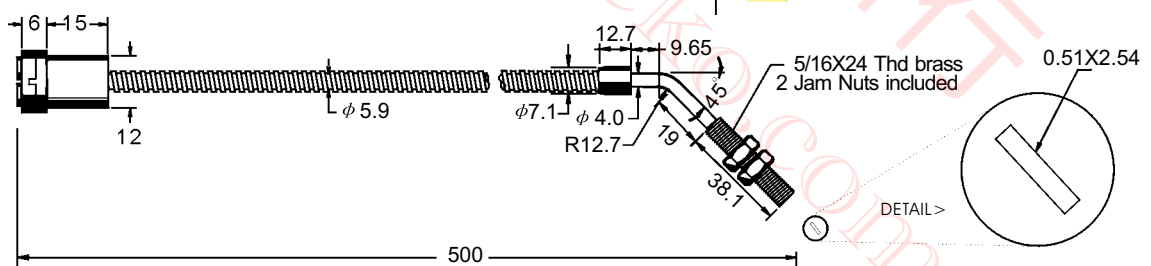

Dimensions (mm)	Model number	Length	Bundle	Sheath	Range (mm)
MIDHR1.29S	MIDHR1.29P	500	0.51x2.54	PVC	
	MIDHR1.29S	500	0.51x2.54	SS	

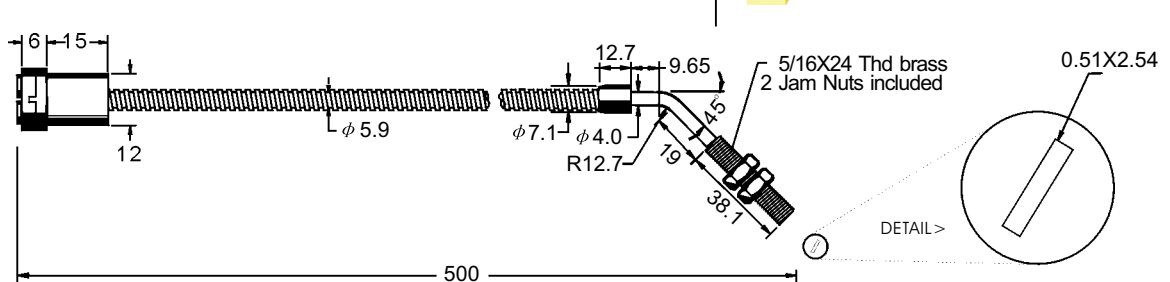

Glass Fibers

Diffuse Mode Bifurcated Cables



Dimensions (mm)	Model number	Length	Bundle	Sheath	Range (mm)
MIP1.6S	MIP1.6P	500	ϕ 1.6	PVC	
	MIP1.6S	500	ϕ 1.6	SS	

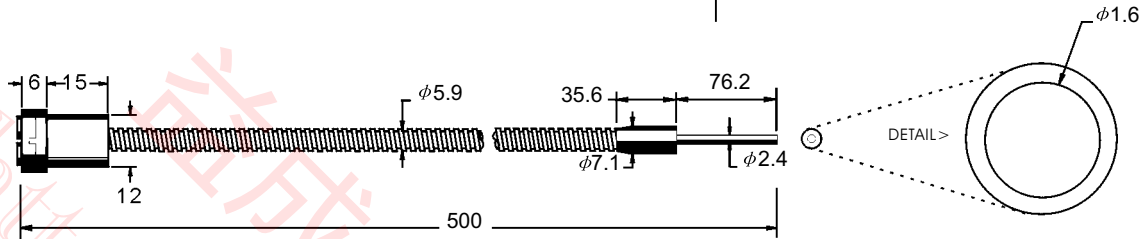

Dimensions (mm)	Model number	Length	Bundle	Sheath	Range (mm)
MIRSR1.95P	MIRSR1.95P	500	0.51x3.91	PVC	
	MIRSR1.95S	500	0.51x3.91	SS	

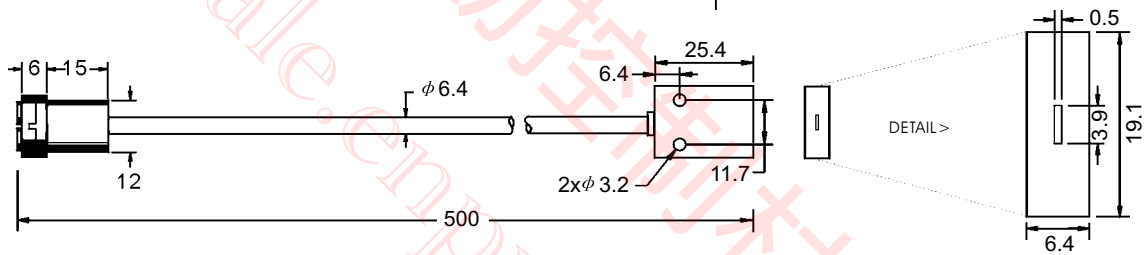

Dimensions (mm)	Model number	Length	Bundle	Sheath	Range (mm)
MIRSR7.86P	MIRSR7.86P	500	0.81x9.70	PVC	
	MIRSR7.86S	500	0.81x9.70	SS	

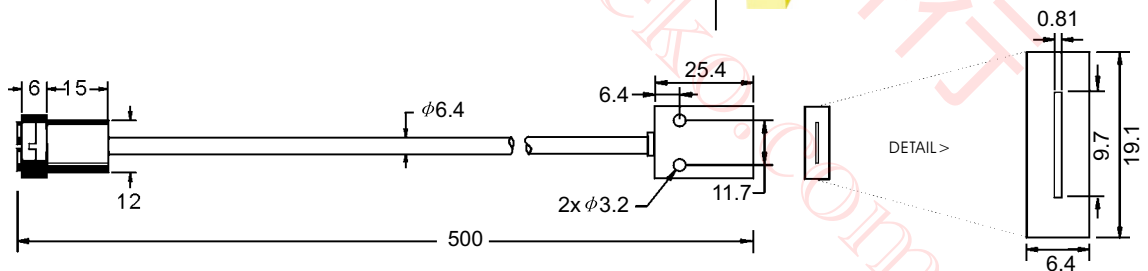

Dimensions (mm)	Model number	Length	Bundle	Sheath	Range (mm)
MIRSR9.53P	MIRSR9.53P	500	0.25x38.1	PVC	
	MIRSR9.53S	500	0.25x38.1	SS	

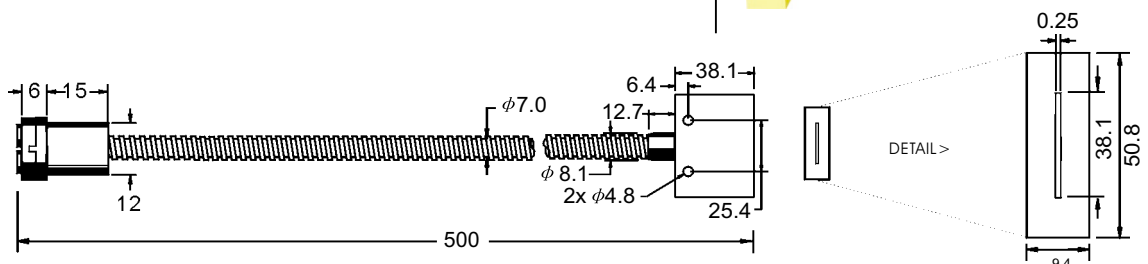

Diffuse Mode

Glass Fibers

Bifurcated Cables



Dimensions (mm)	Model number	Length	Bundle	Sheath	Range (mm)
-----------------	--------------	--------	--------	--------	------------

MIMAM.7P

MIMAM.7P	500	ϕ 0.7	PVC
----------	-----	------------	-----

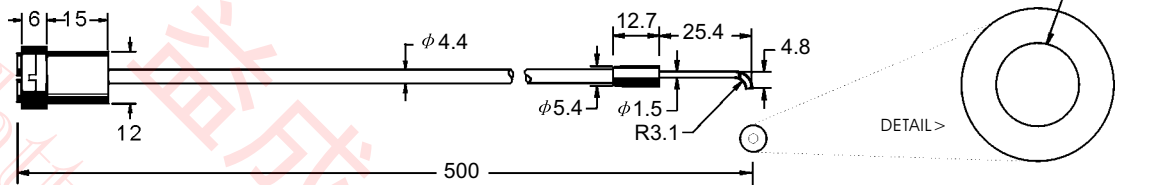

Dimensions (mm)	Model number	Length	Bundle	Sheath	Range (mm)
-----------------	--------------	--------	--------	--------	------------

MIMAM1.2P

MIMAM1.2P	500	ϕ 1.2	PVC
-----------	-----	------------	-----

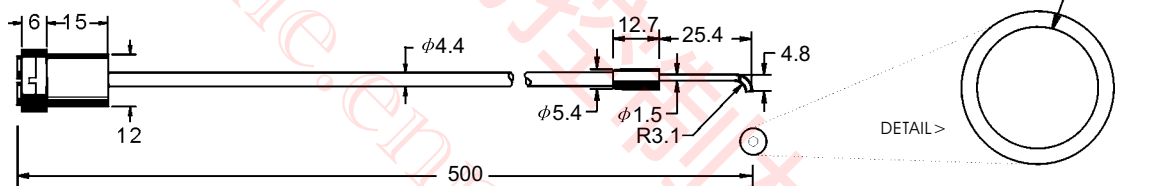

Dimensions (mm)	Model number	Length	Bundle	Sheath	Range (mm)
-----------------	--------------	--------	--------	--------	------------

MIMHM.7P

MIMHM.7P	500	ϕ 0.7	PVC
----------	-----	------------	-----

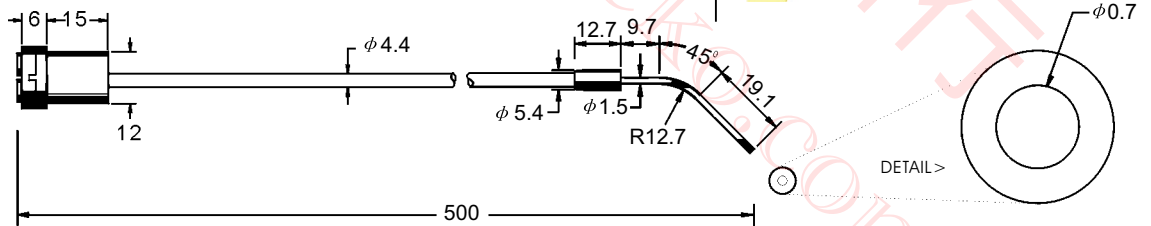

Dimensions (mm)	Model number	Length	Bundle	Sheath	Range (mm)
-----------------	--------------	--------	--------	--------	------------

MIMHM1.2P

MIMHM1.2P	500	ϕ 1.2	PVC
-----------	-----	------------	-----

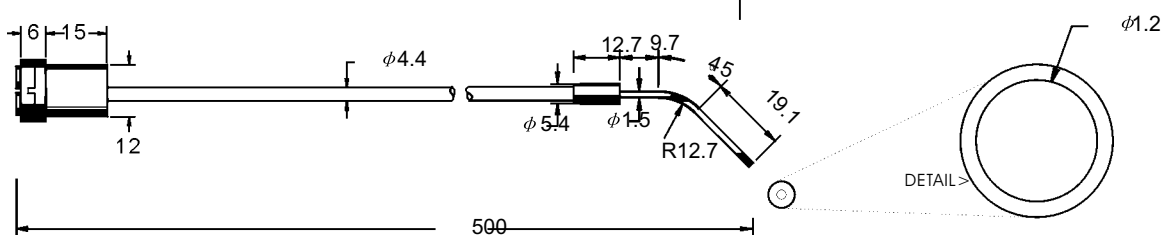

Glass Fibers

Diffuse Mode Bifurcated Cables



Dimensions (mm)	Model number	Length	Bundle	Sheath	Range (mm)
-----------------	--------------	--------	--------	--------	------------

MIMS1.7P

MIMS1.7P	500	ϕ 0.7	PVC
----------	-----	------------	-----

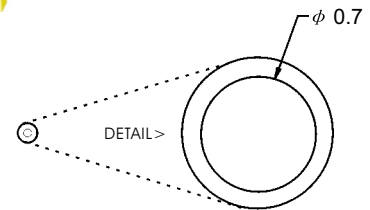
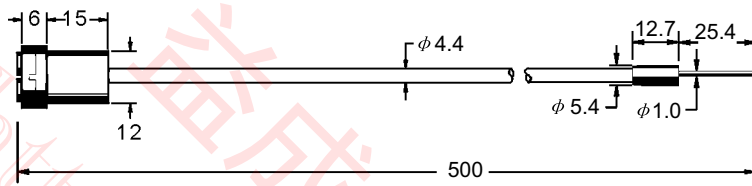

Dimensions (mm)	Model number	Length	Bundle	Sheath	Range (mm)
-----------------	--------------	--------	--------	--------	------------

MIMS1.2P

MIMS1.2P	500	ϕ 1.2	PVC
----------	-----	------------	-----

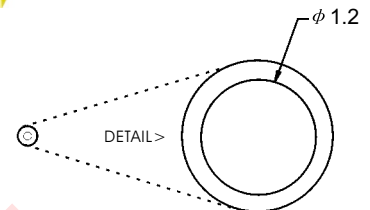
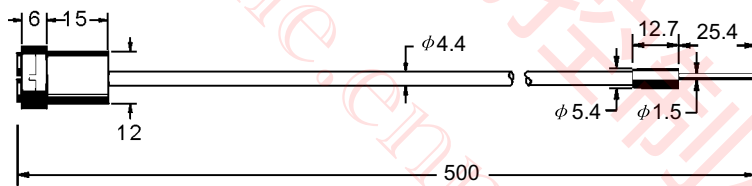

Dimensions (mm)	Model number	Length	Bundle	Sheath	Range (mm)
-----------------	--------------	--------	--------	--------	------------

MISAM.7P

MISAM.7P	500	ϕ 0.7	PVC
----------	-----	------------	-----

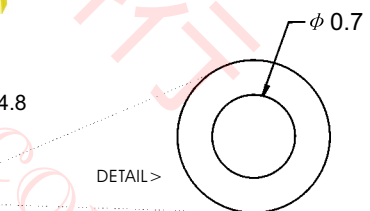
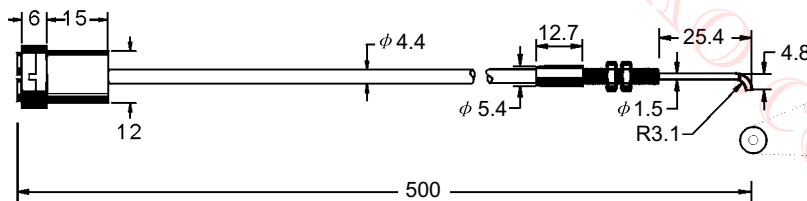

Dimensions (mm)	Model number	Length	Bundle	Sheath	Range (mm)
-----------------	--------------	--------	--------	--------	------------

MISAM1.2P

MISAM1.2P	500	ϕ 1.2	PVC
-----------	-----	------------	-----

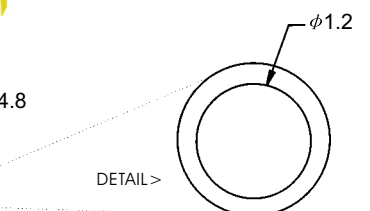
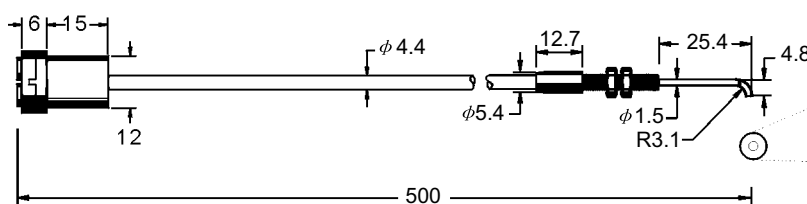

Glass Fibers

Diffuse Mode

Bifurcated Cables



Dimensions (mm)	Model number	Length	Bundle	Sheath	Range (mm)
-----------------	--------------	--------	--------	--------	------------

MISHM.7P

MISHM.7P	500	ϕ 0.7	PVC
----------	-----	------------	-----

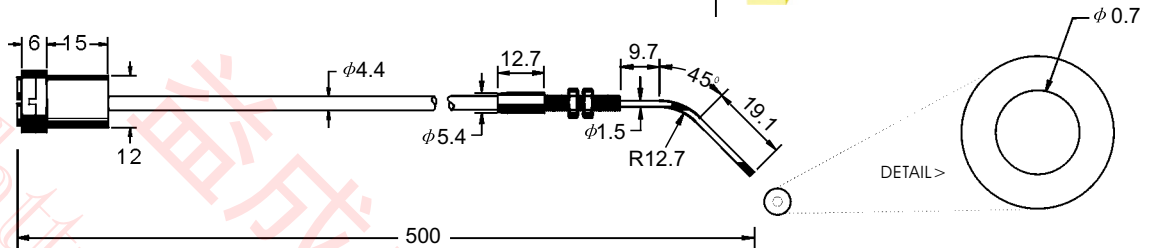

Dimensions (mm)	Model number	Length	Bundle	Sheath	Range (mm)
-----------------	--------------	--------	--------	--------	------------

MISHM1.2P

MISHM1.2P	500	ϕ 1.2	PVC
-----------	-----	------------	-----

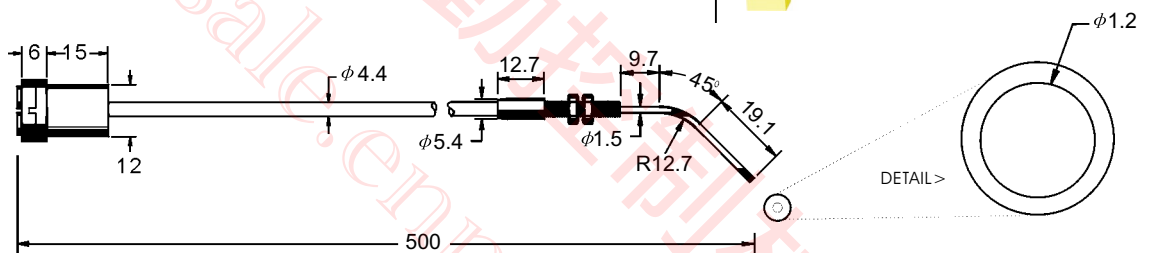

Dimensions (mm)	Model number	Length	Bundle	Sheath	Range (mm)
-----------------	--------------	--------	--------	--------	------------

MISS.7P

MISS.7P	500	ϕ 0.7	PVC
---------	-----	------------	-----

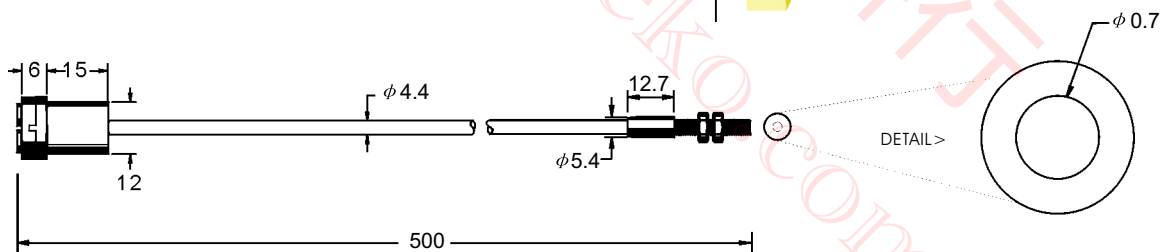

Dimensions (mm)	Model number	Length	Bundle	Sheath	Range (mm)
-----------------	--------------	--------	--------	--------	------------

MISS1.2P

MISS1.2P	500	ϕ 1.2	PVC
----------	-----	------------	-----

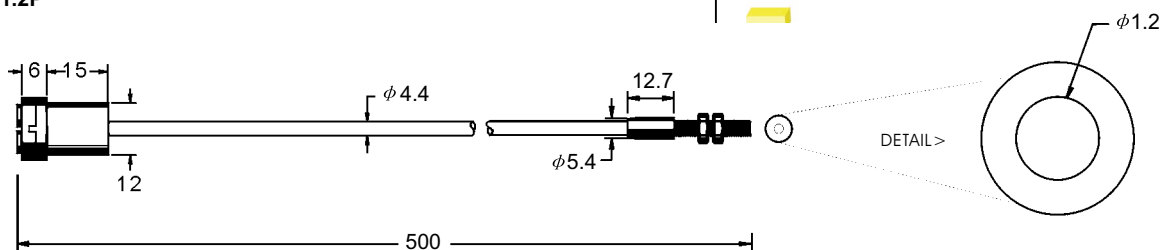

Glass Fibers

Diffuse Mode Bifurcated Cables



Dimensions (mm)	Model number	Length	Bundle	Sheath	Range (mm)
MISSM.7P	MISSM.7P	500	φ 0.7	PVC	

MISSM.7P

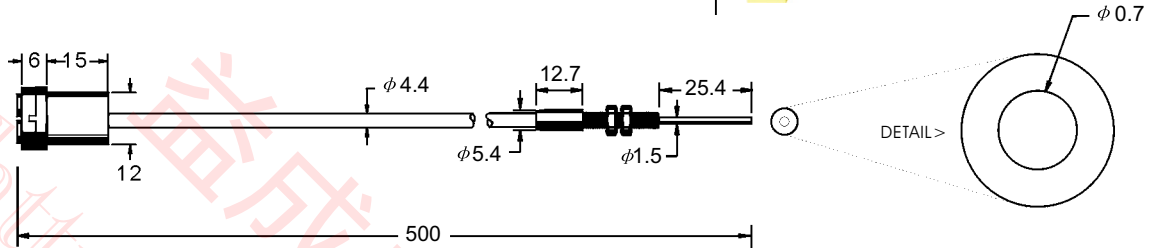

Dimensions (mm)	Model number	Length	Bundle	Sheath	Range (mm)
MISSM1.2P	MISSM1.2P	500	φ 1.2	PVC	

MISSM1.2P

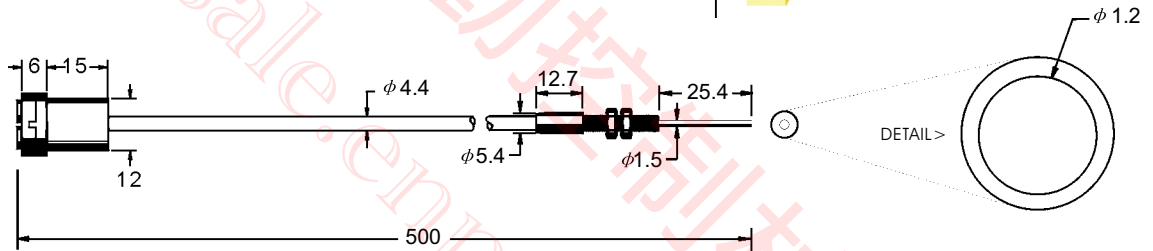

Dimensions (mm)	Model number	Length	Bundle	Sheath	Range (mm)

Dimensions (mm)	Model number	Length	Bundle	Sheath	Range (mm)

Glass Fibers

Diffuse Mode

Bifurcated Cables



Dimensions (mm)	Model number	Length	Bundle	Sheath	Range (mm)
-----------------	--------------	--------	--------	--------	------------

EIN.5P

EIN.5P

500

ϕ 0.5

PVC

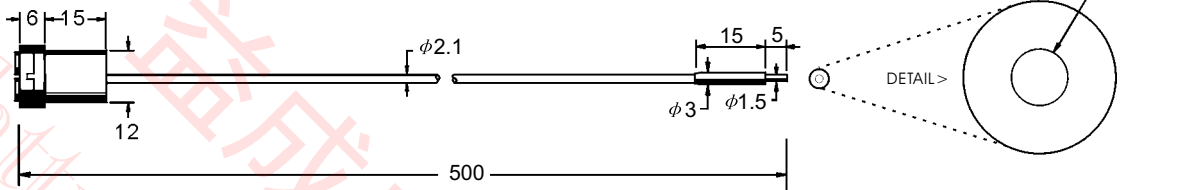

Dimensions (mm)	Model number	Length	Bundle	Sheath	Range (mm)
-----------------	--------------	--------	--------	--------	------------

EIN1.1P

EIN1.1P

500

ϕ 1.1

PVC

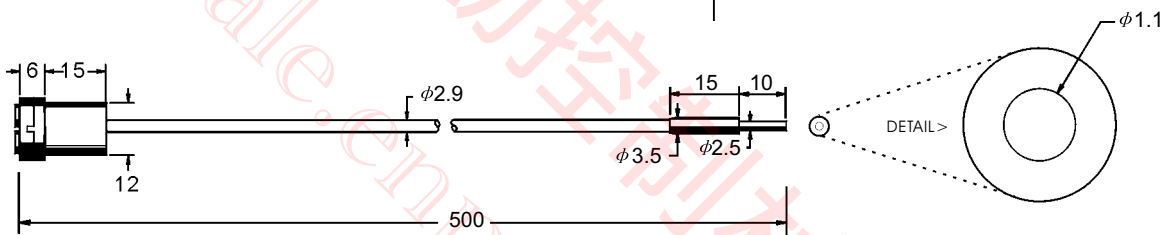

Dimensions (mm)	Model number	Length	Bundle	Sheath	Range (mm)
-----------------	--------------	--------	--------	--------	------------

EIE.8P

EIE.8P

500

ϕ 0.8

PVC

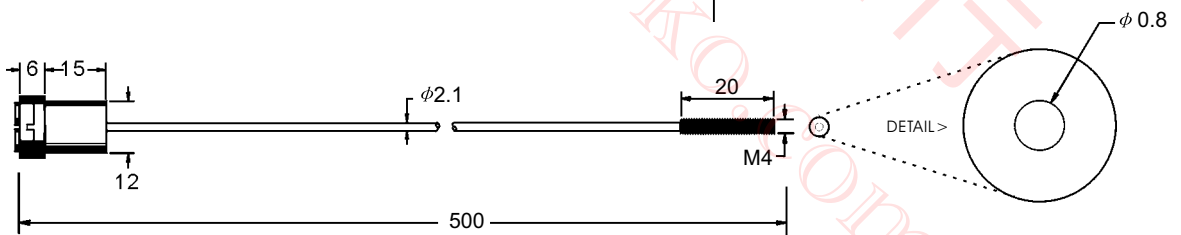

Dimensions (mm)	Model number	Length	Bundle	Sheath	Range (mm)
-----------------	--------------	--------	--------	--------	------------

EIE1.6P

EIE1.6P

500

ϕ 1.6

PVC

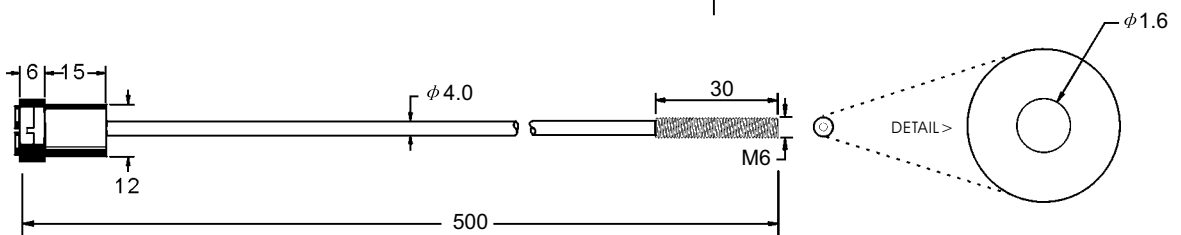

Glass Fibers

Diffuse Mode Bifurcated Cables



Dimensions (mm)	Model number	Length	Bundle	Sheath	Range (mm)
-----------------	--------------	--------	--------	--------	------------

EIB.8P

EIB.8P

500

ϕ 0.8

PVC

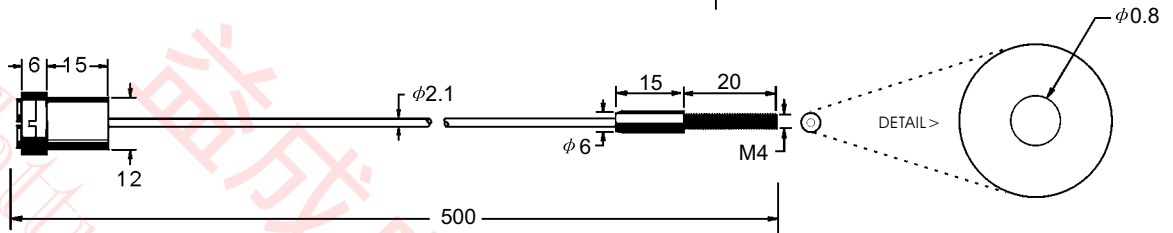

Dimensions (mm)	Model number	Length	Bundle	Sheath	Range (mm)
-----------------	--------------	--------	--------	--------	------------

EIB1.6P

EIB1.6P

500

ϕ 1.6

PVC

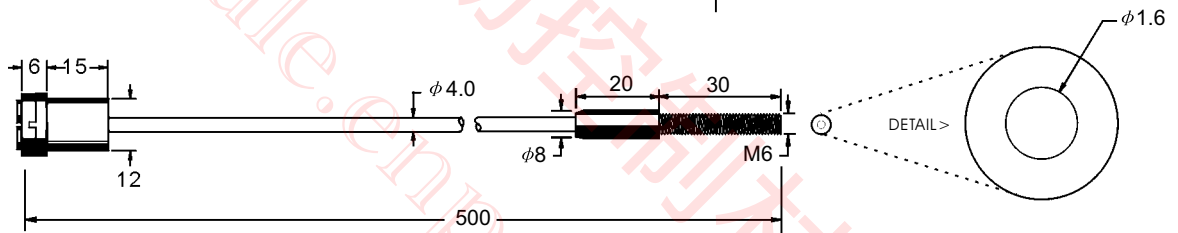

Dimensions (mm)	Model number	Length	Bundle	Sheath	Range (mm)
-----------------	--------------	--------	--------	--------	------------

EINW.8P

EINW.8P

500

ϕ 0.8

PVC

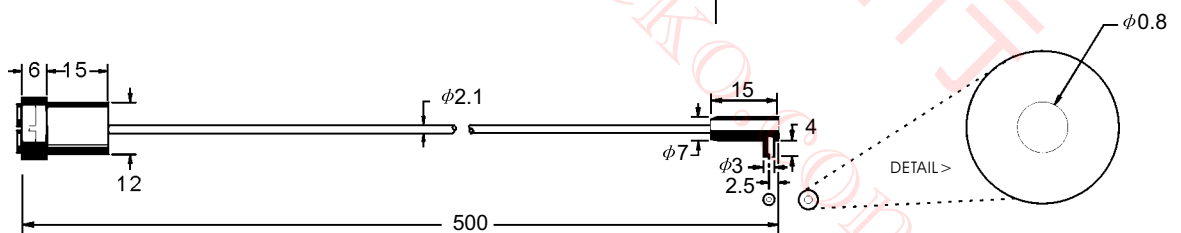

Dimensions (mm)	Model number	Length	Bundle	Sheath	Range (mm)
-----------------	--------------	--------	--------	--------	------------

EINW1.6P

EINW1.6P

500

ϕ 1.6

PVC

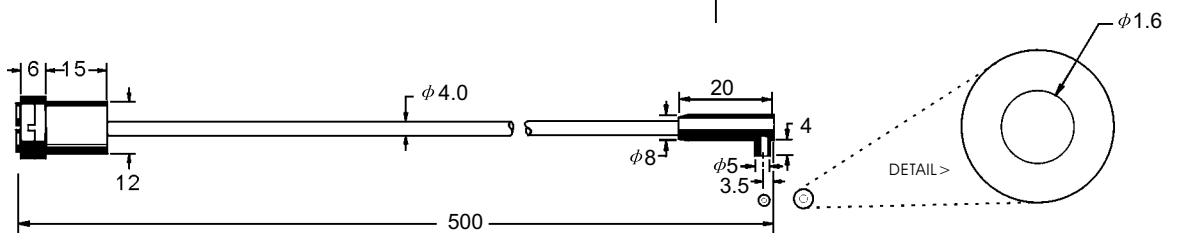

Glass Fibers

Diffuse Mode

Bifurcated Cables



Dimensions (mm)	Model number	Length	Bundle	Sheath	Range (mm)
-----------------	--------------	--------	--------	--------	------------

EIN2.3N

EIN2.3N	500	ϕ 2.3	N
---------	-----	------------	---

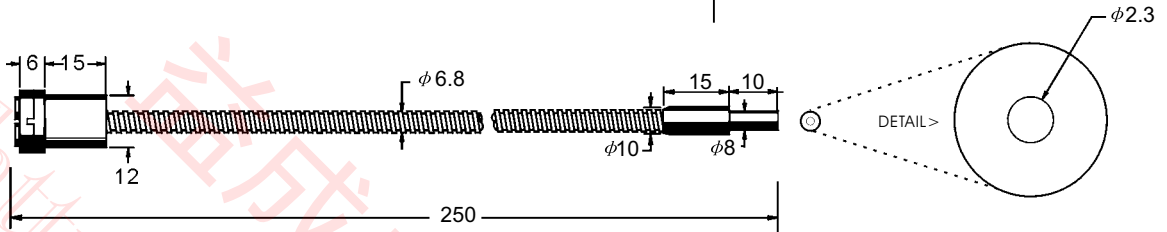

Dimensions (mm)	Model number	Length	Bundle	Sheath	Range (mm)
-----------------	--------------	--------	--------	--------	------------

EIN.8N

EIN.8N	500	ϕ 0.8	N
--------	-----	------------	---

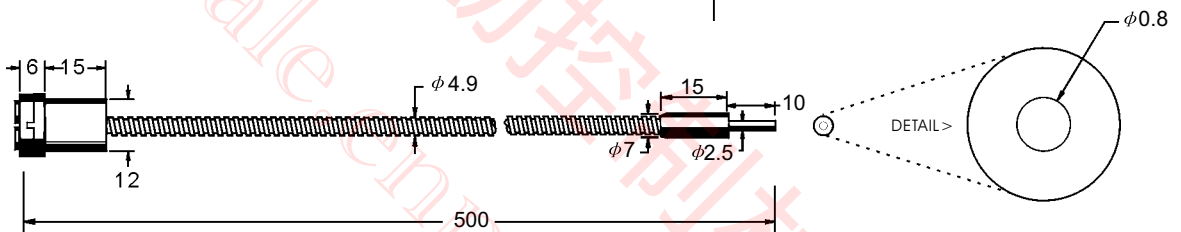

Dimensions (mm)	Model number	Length	Bundle	Sheath	Range (mm)
-----------------	--------------	--------	--------	--------	------------

EIB.8N

EIB.8N	500	ϕ 0.8	N
--------	-----	------------	---

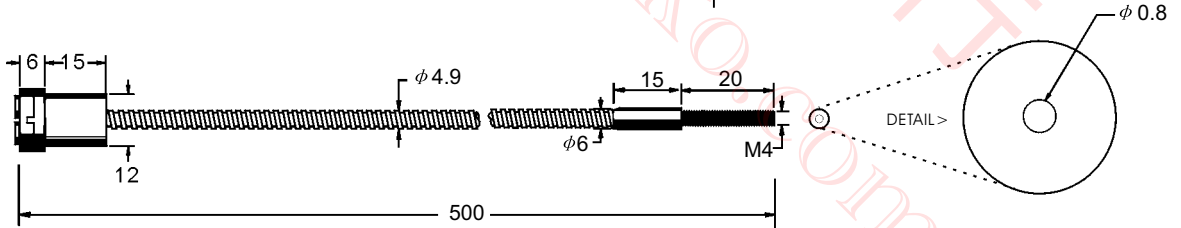

Dimensions (mm)	Model number	Length	Bundle	Sheath	Range (mm)
-----------------	--------------	--------	--------	--------	------------

EIB1.1N

EIB1.1N	500	ϕ 1.1	N
---------	-----	------------	---

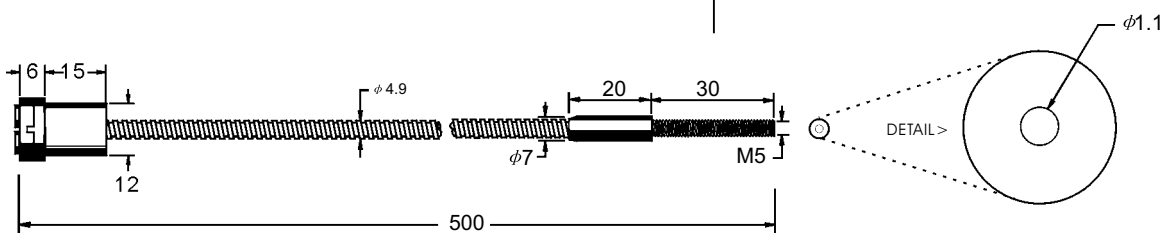

Glass Fibers

Diffuse Mode Bifurcated Cables



Dimensions (mm)	Model number	Length	Bundle	Sheath	Range (mm)
EIB1.6N	EIB1.6N	500	ϕ 1.6	N	

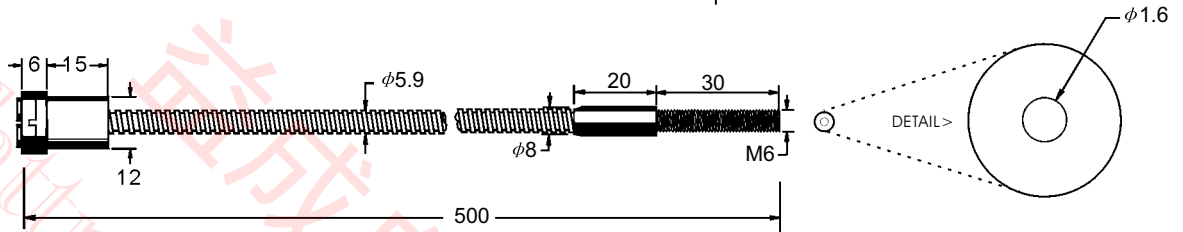

Dimensions (mm)	Model number	Length	Bundle	Sheath	Range (mm)
EIB2.3N	EIB2.3N	500	ϕ 2.3	N	

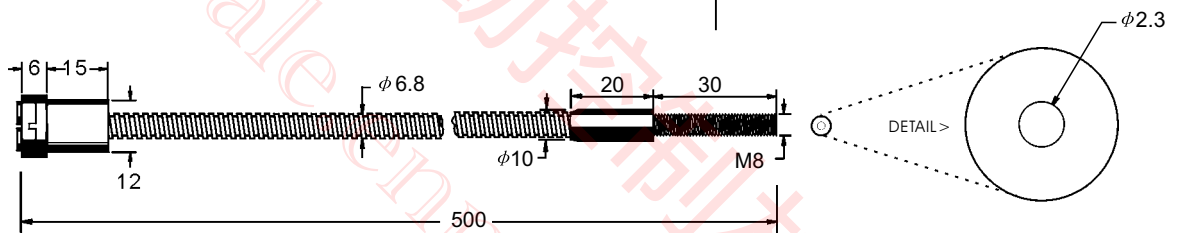

Dimensions (mm)	Model number	Length	Bundle	Sheath	Range (mm)

Dimensions (mm)	Model number	Length	Bundle	Sheath	Range (mm)

Glass Fibers

Diffuse Mode

Bifurcated Cables

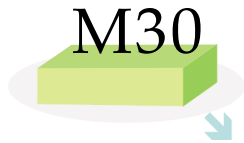

Dimensions (mm)	Model number	Length	Bundle	Sheath	Range (mm)
-----------------	--------------	--------	--------	--------	------------

TIN.5P

TIN.5P	500	ϕ 0.5	PVC
--------	-----	------------	-----

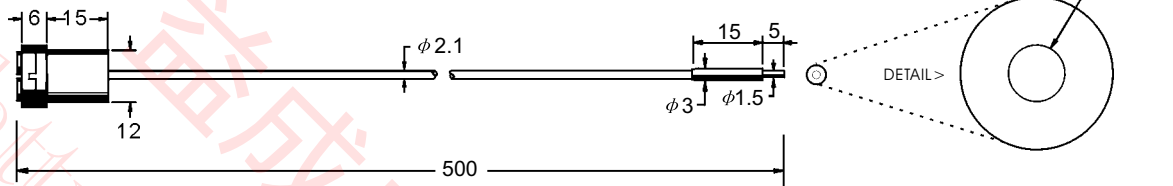
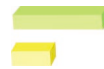

Dimensions (mm)	Model number	Length	Bundle	Sheath	Range (mm)
-----------------	--------------	--------	--------	--------	------------

TIE1.1P

TIE1.1P	500	ϕ 1.1	PVC
---------	-----	------------	-----

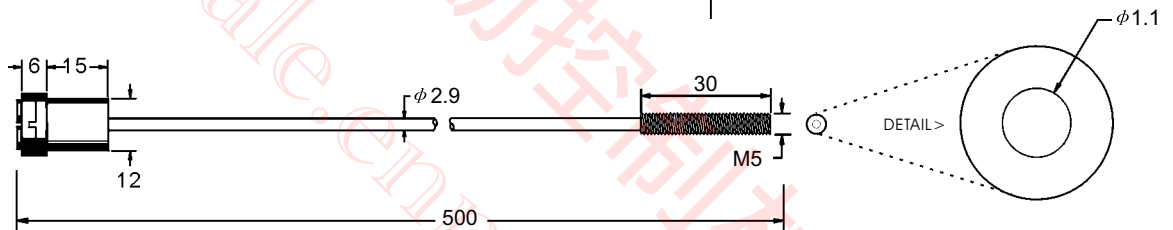

Dimensions (mm)	Model number	Length	Bundle	Sheath	Range (mm)
-----------------	--------------	--------	--------	--------	------------

TIB1.1P

TIB1.1P	500	ϕ 1.1	PVC
---------	-----	------------	-----

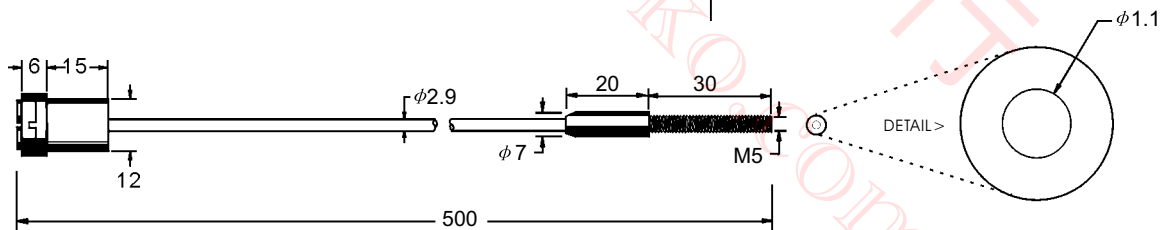

Dimensions (mm)	Model number	Length	Bundle	Sheath	Range (mm)
-----------------	--------------	--------	--------	--------	------------

TIN7/1P

TIN7/1P	500	ϕ 7/1	PVC
---------	-----	------------	-----

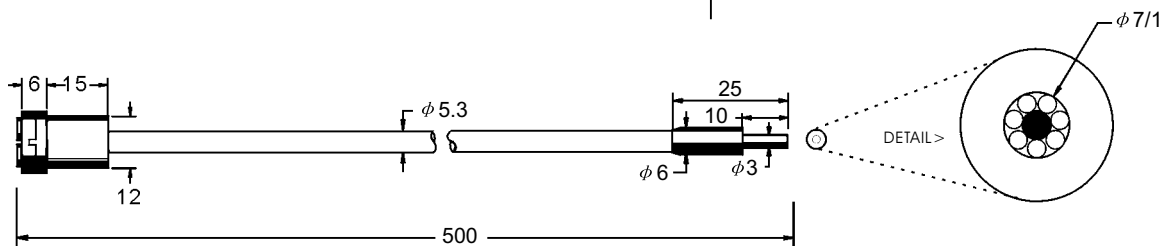

Glass Fibers

Diffuse Mode Bifurcated Cables

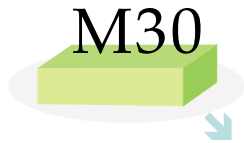

Dimensions (mm)	Model number	Length	Bundle	Sheath	Range (mm)
-----------------	--------------	--------	--------	--------	------------

TINW3N

TINW3N	500	ϕ 3.0	N	
--------	-----	------------	---	--

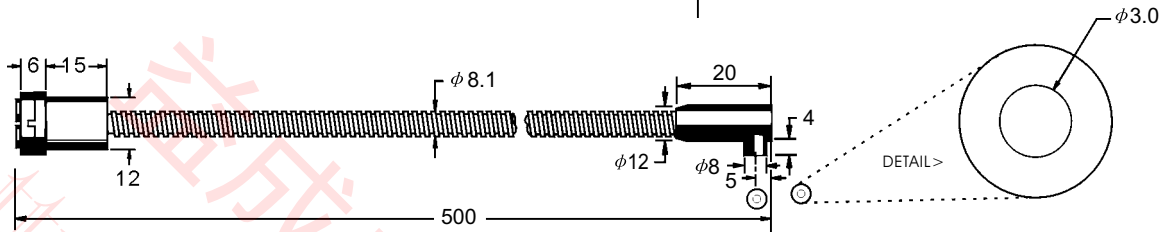

Dimensions (mm)	Model number	Length	Bundle	Sheath	Range (mm)
-----------------	--------------	--------	--------	--------	------------

TIB1.6N

TIB1.6N	500	ϕ 1.6	N	
---------	-----	------------	---	--

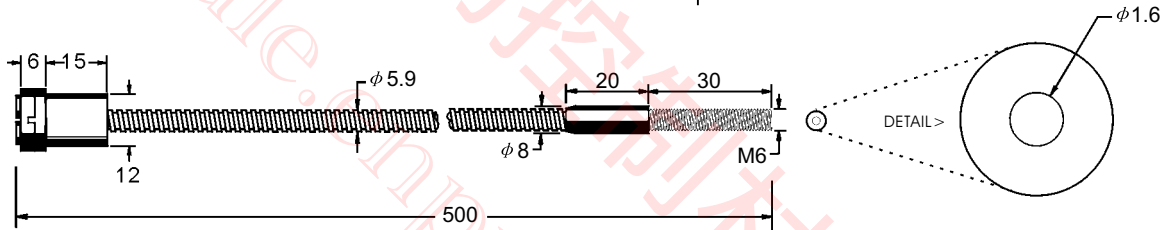

Dimensions (mm)	Model number	Length	Bundle	Sheath	Range (mm)
-----------------	--------------	--------	--------	--------	------------

TIB2.3N

TIB2.3N	500	ϕ 2.3	N	
---------	-----	------------	---	--

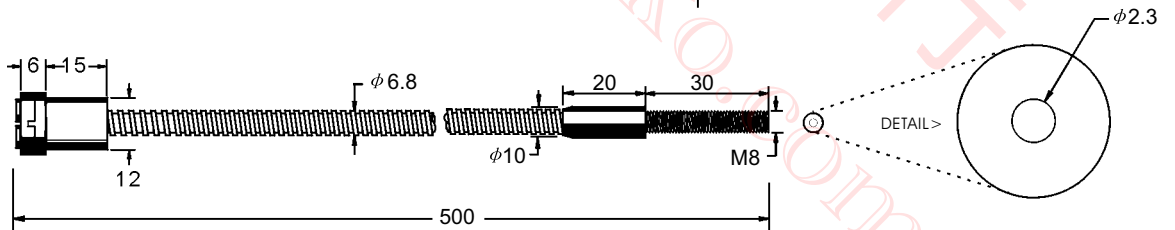

Dimensions (mm)	Model number	Length	Bundle	Sheath	Range (mm)
-----------------	--------------	--------	--------	--------	------------

TIB3N

TIB3N	500	ϕ 3.0	N	
-------	-----	------------	---	--

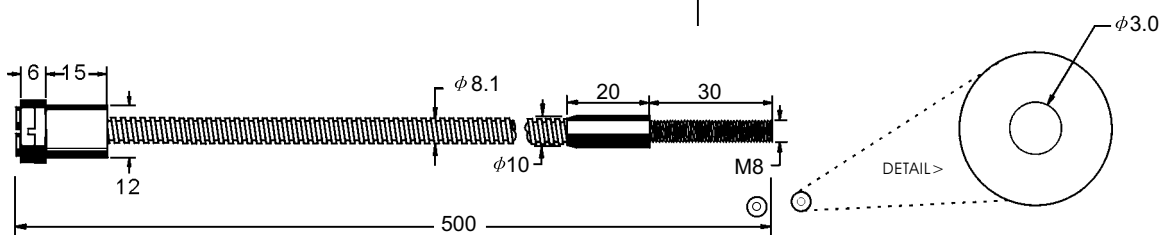

Glass Fibers

Opposed Mode Individual Cables



Dimensions (mm)	Model number	Length	Bundle	Sheath	Range (mm)
-----------------	--------------	--------	--------	--------	------------

MBN.8P

MBN.8P	500	ϕ 0.8	PVC
--------	-----	------------	-----

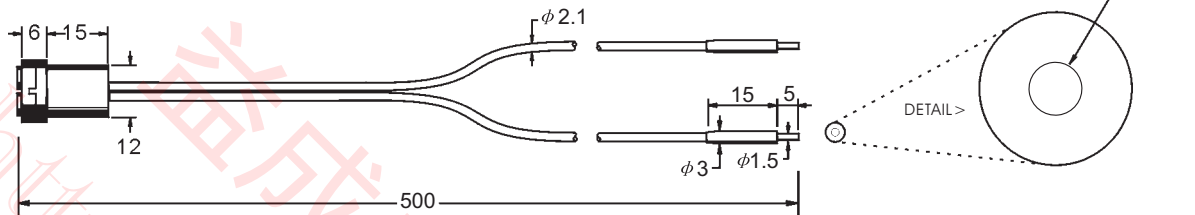

Dimensions (mm)	Model number	Length	Bundle	Sheath	Range (mm)
-----------------	--------------	--------	--------	--------	------------

MBN1.1P

MBN1.1P	500	ϕ 1.1	PVC
---------	-----	------------	-----

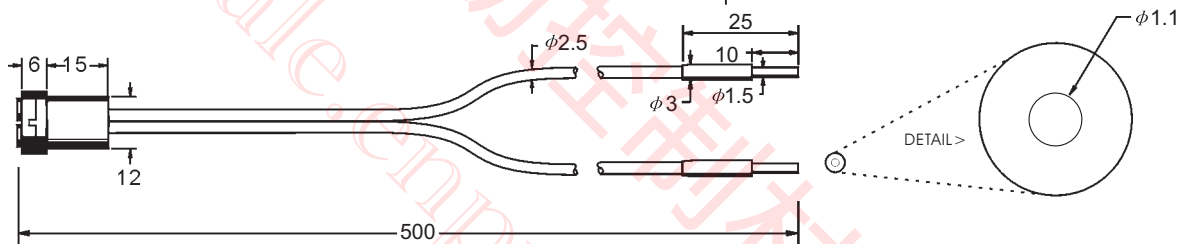

Dimensions (mm)	Model number	Length	Bundle	Sheath	Range (mm)
-----------------	--------------	--------	--------	--------	------------

MBN1.1P-1

MBN1.1P-1	500	ϕ 1.1	PVC
-----------	-----	------------	-----

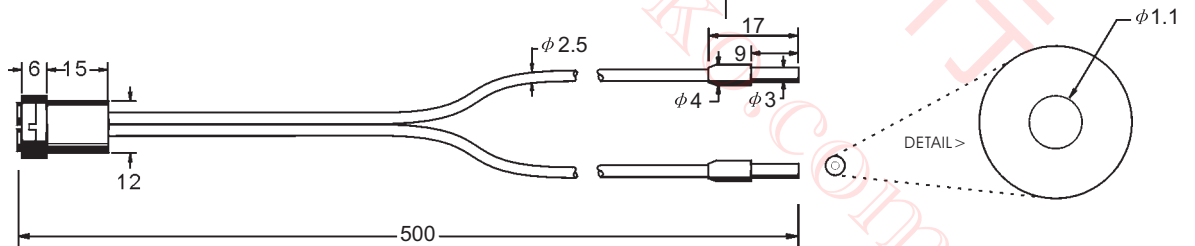

Dimensions (mm)	Model number	Length	Bundle	Sheath	Range (mm)
-----------------	--------------	--------	--------	--------	------------

MBN1.6R

MBN1.6R	500	ϕ 1.6	PUR
---------	-----	------------	-----

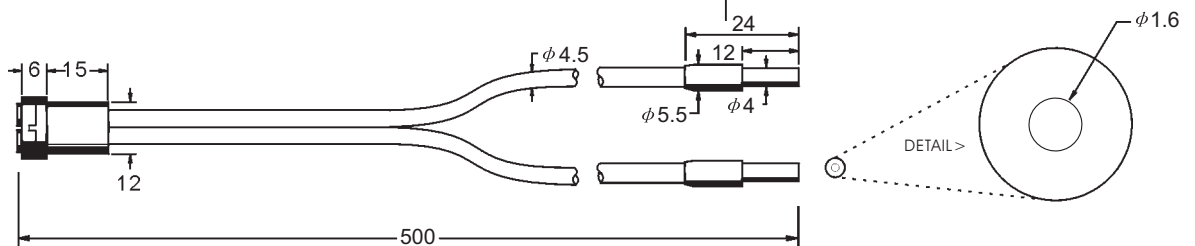

Glass Fibers

Opposed Mode

Individual Cables

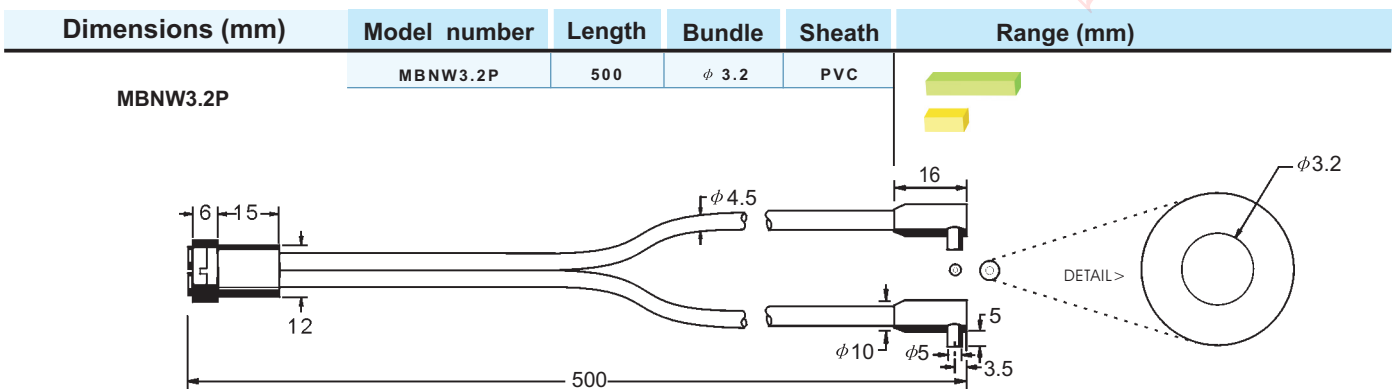
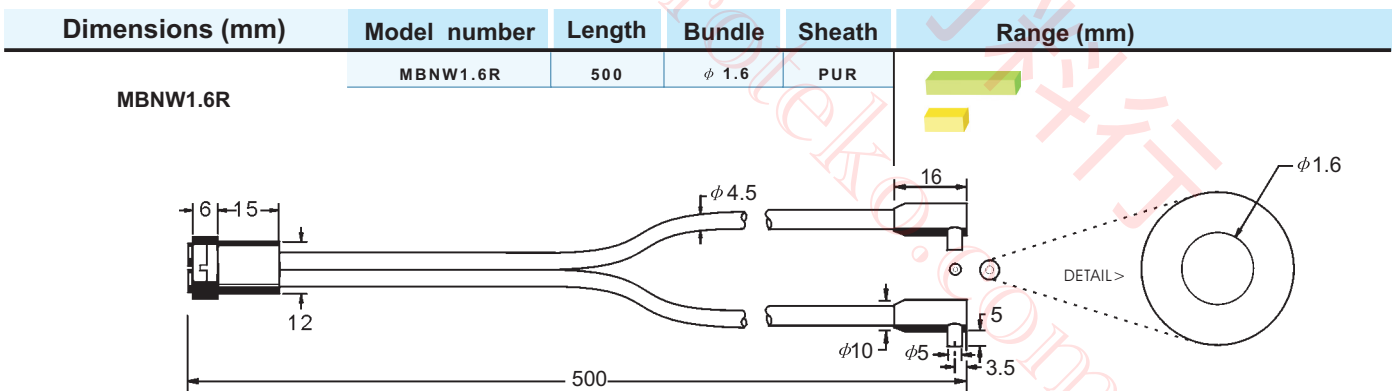
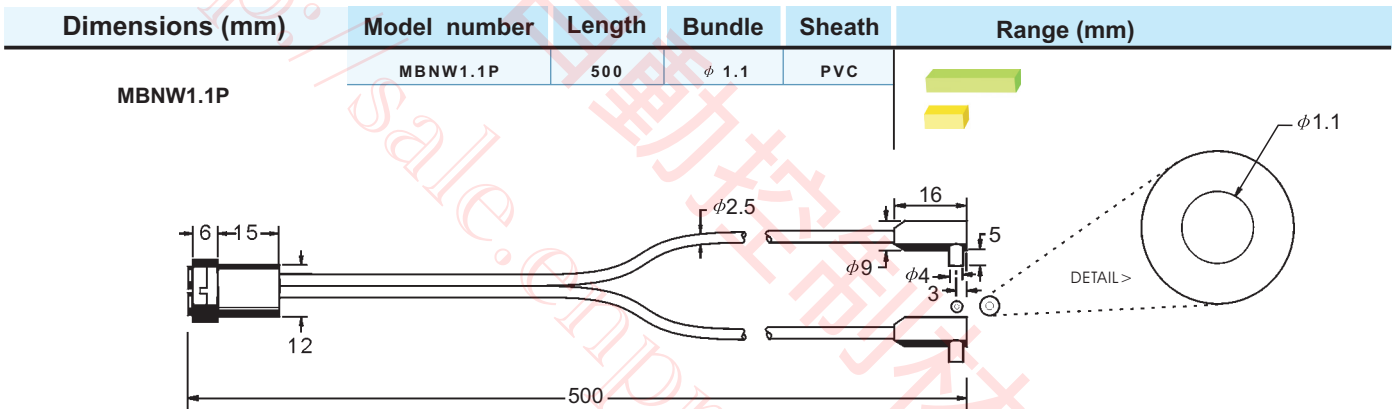
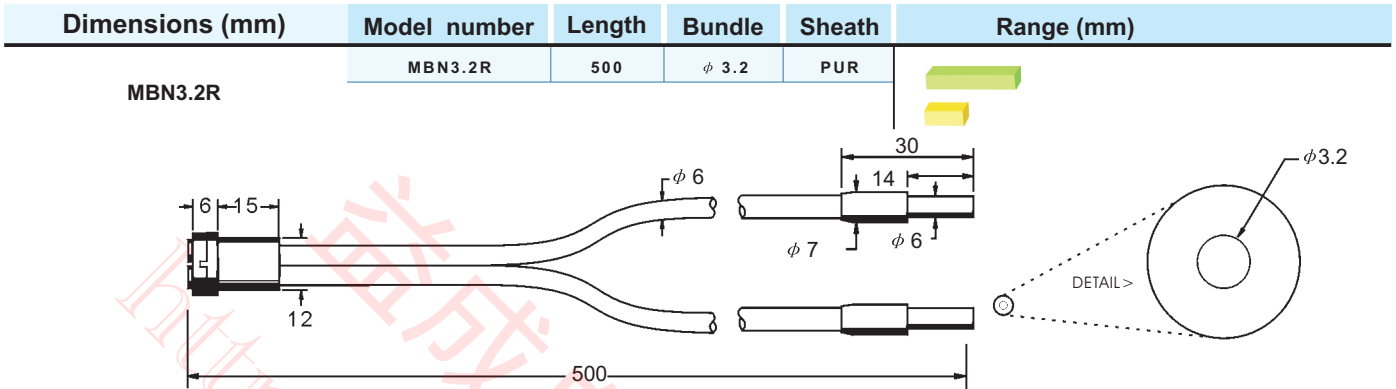

Glass Fibers

Opposed Mode Individual Cables



Dimensions (mm)	Model number	Length	Bundle	Sheath	Range (mm)
-----------------	--------------	--------	--------	--------	------------

MBC1.1P

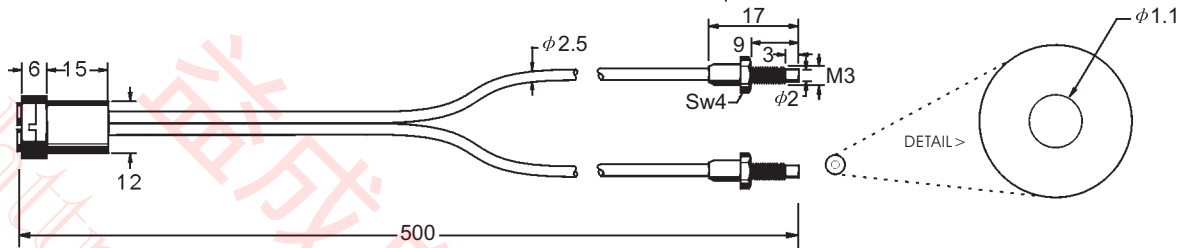

Dimensions (mm)	Model number	Length	Bundle	Sheath	Range (mm)
-----------------	--------------	--------	--------	--------	------------

MBC1.6R

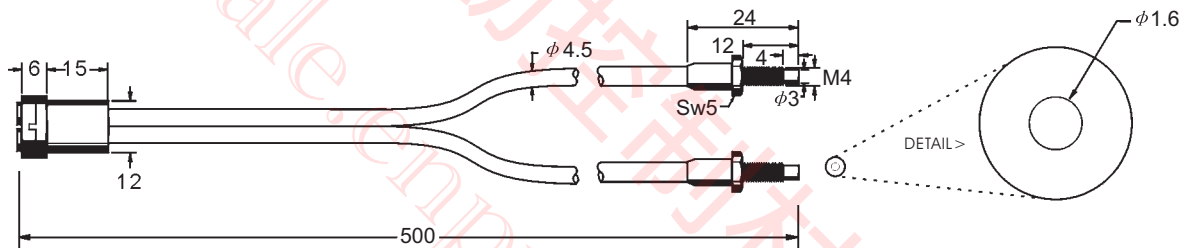

Dimensions (mm)	Model number	Length	Bundle	Sheath	Range (mm)
-----------------	--------------	--------	--------	--------	------------

MBC3.2P

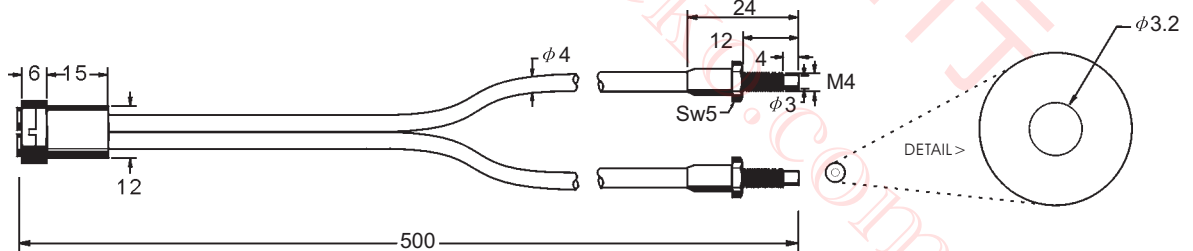

Dimensions (mm)	Model number	Length	Bundle	Sheath	Range (mm)
-----------------	--------------	--------	--------	--------	------------

MBNW2.3W-3

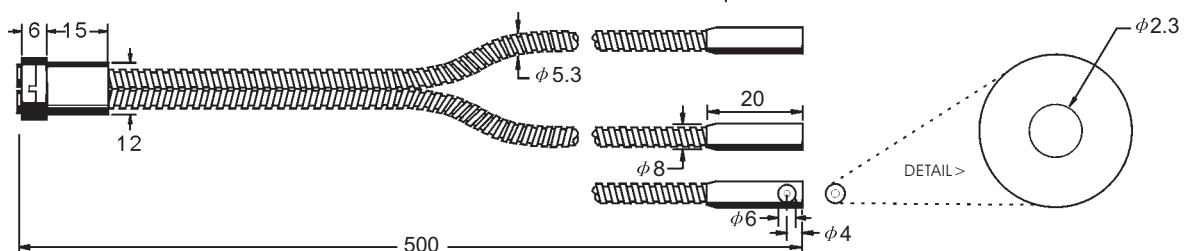

Glass Fibers

Opposed Mode Individual Cables



Dimensions (mm)	Model number	Length	Bundle	Sheath	Range (mm)
-----------------	--------------	--------	--------	--------	------------

MBN1.1M

MBN1.1M	500	ϕ 1.1	M	
---------	-----	------------	---	--

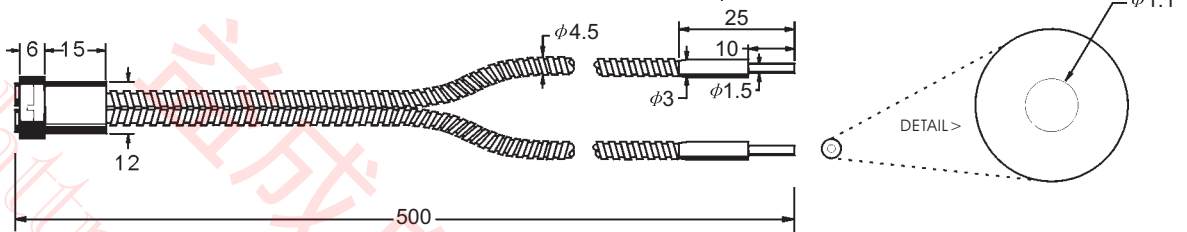

Dimensions (mm)	Model number	Length	Bundle	Sheath	Range (mm)
-----------------	--------------	--------	--------	--------	------------

MBN1.1M-1

MBN1.1M-1	500	ϕ 1.1	M	
-----------	-----	------------	---	--

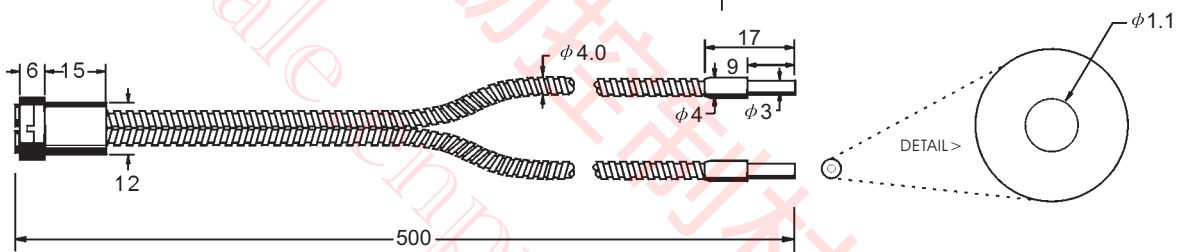

Dimensions (mm)	Model number	Length	Bundle	Sheath	Range (mm)
-----------------	--------------	--------	--------	--------	------------

MBN2.3W

MBN2.3W	500	ϕ 2.3	W	
---------	-----	------------	---	--

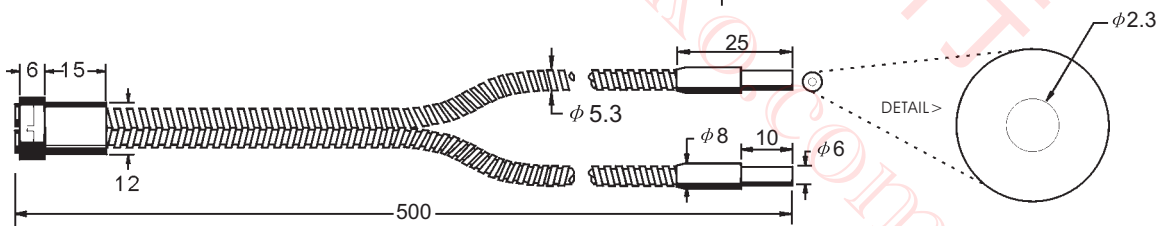

Dimensions (mm)	Model number	Length	Bundle	Sheath	Range (mm)
-----------------	--------------	--------	--------	--------	------------

MBN1.6M

MBN1.6M	500	ϕ 1.6	M	
---------	-----	------------	---	--

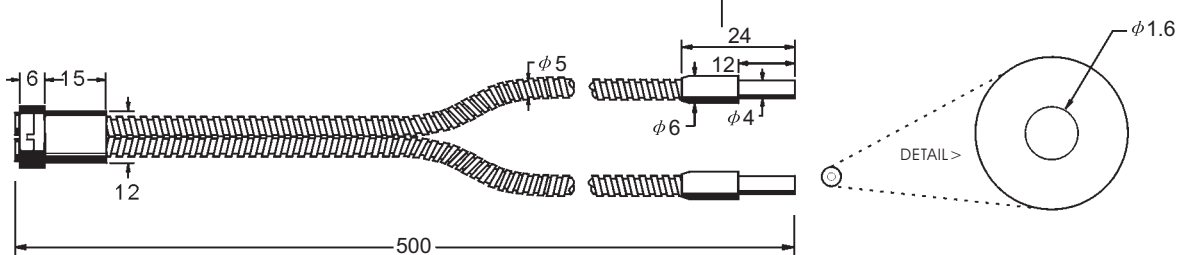

Glass Fibers

Opposed Mode Individual Cables



Dimensions (mm)	Model number	Length	Bundle	Sheath	Range (mm)
-----------------	--------------	--------	--------	--------	------------

MBN3.2M

MBN3.2M	500	ϕ 3.2	M	
---------	-----	------------	---	--

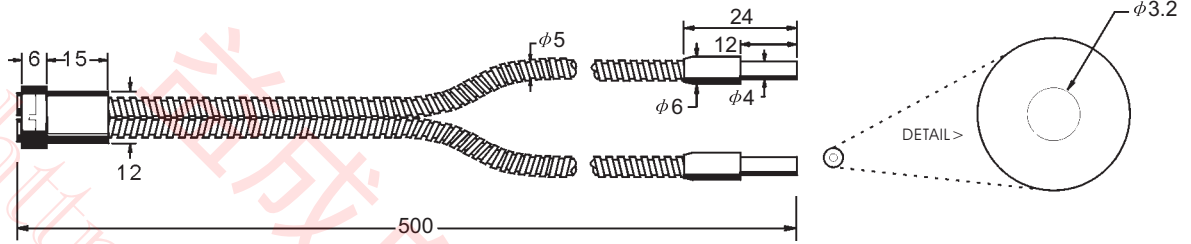

Dimensions (mm)	Model number	Length	Bundle	Sheath	Range (mm)
-----------------	--------------	--------	--------	--------	------------

MBB1.1N

MBB1.1N	500	ϕ 1.1	N	
---------	-----	------------	---	--

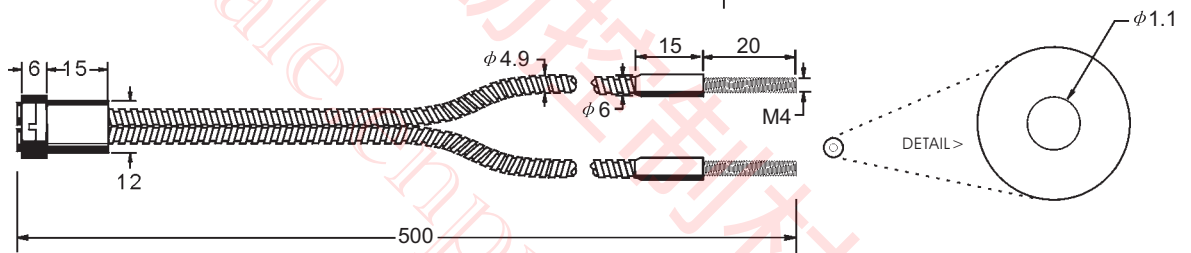

Dimensions (mm)	Model number	Length	Bundle	Sheath	Range (mm)
-----------------	--------------	--------	--------	--------	------------

MBB1.6N

MBB1.6N	500	ϕ 1.6	N	
---------	-----	------------	---	--

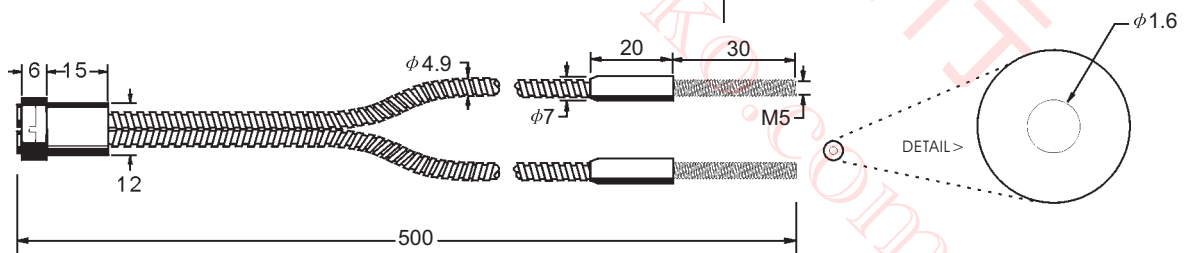

Dimensions (mm)	Model number	Length	Bundle	Sheath	Range (mm)
-----------------	--------------	--------	--------	--------	------------

MBF1.6M

MBF1.6M	500	ϕ 1.6	M	
---------	-----	------------	---	--

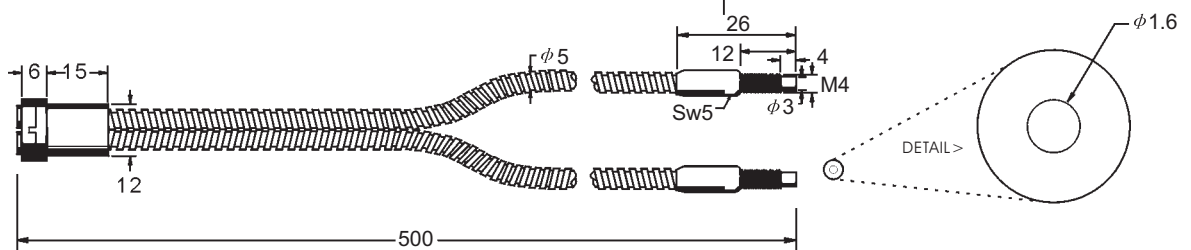

Opposed Mode

Glass Fibers

Individual Cables



Dimensions (mm)	Model number	Length	Bundle	Sheath	Range (mm)
-----------------	--------------	--------	--------	--------	------------

MBF3.2M

MBF3.2M	500	ϕ 3.2	M	
---------	-----	------------	---	--

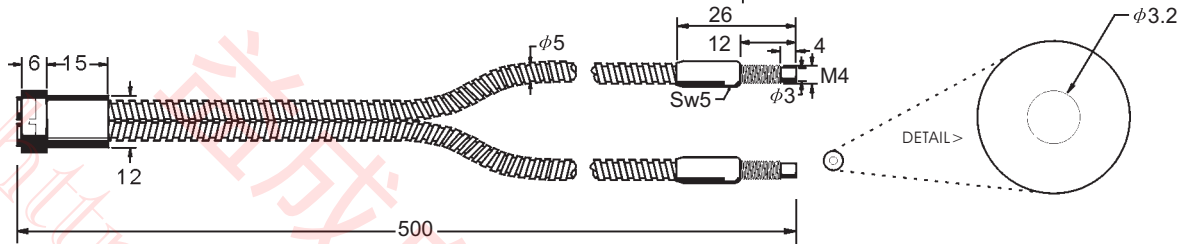

Dimensions (mm)	Model number	Length	Bundle	Sheath	Range (mm)
-----------------	--------------	--------	--------	--------	------------

MBC1.1M

MBC1.1M	500	ϕ 1.1	M	
---------	-----	------------	---	--

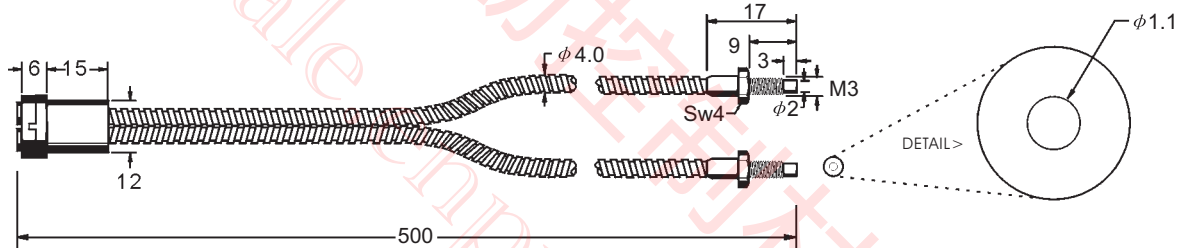

Dimensions (mm)	Model number	Length	Bundle	Sheath	Range (mm)
-----------------	--------------	--------	--------	--------	------------

MBNW1.6M

MBNW1.6M	500	ϕ 1.6	M	
----------	-----	------------	---	--

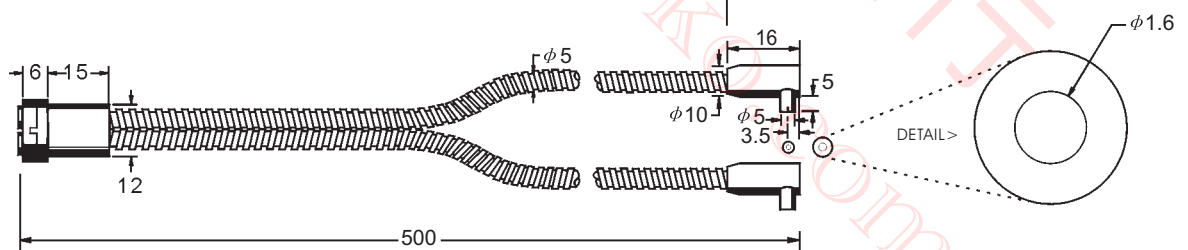

Dimensions (mm)	Model number	Length	Bundle	Sheath	Range (mm)
-----------------	--------------	--------	--------	--------	------------

MBNW3.2M

MBNW3.2M	500	ϕ 3.2	M	
----------	-----	------------	---	--

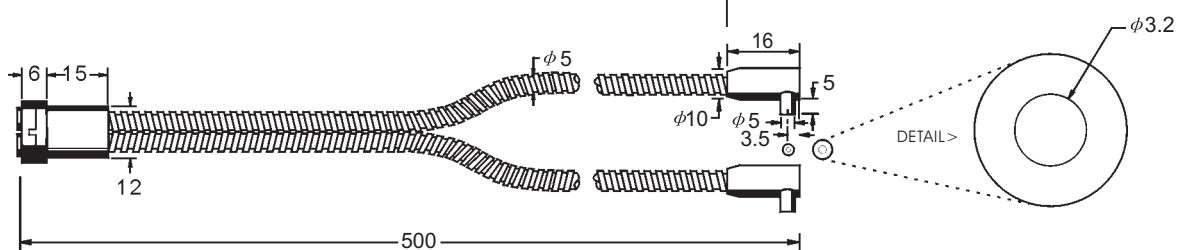

Glass Fibers

Opposed Mode Individual Cables



Dimensions (mm)	Model number	Length	Bundle	Sheath	Range (mm)
-----------------	--------------	--------	--------	--------	------------

MBNW2.3W

MBNW2.3W	500	ϕ 2.3	W	
----------	-----	------------	---	--

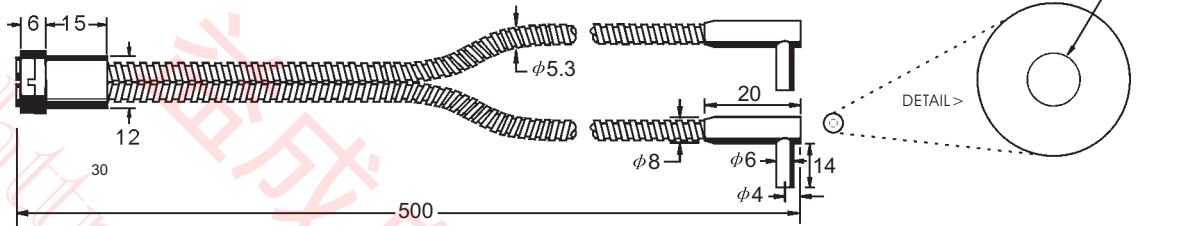

Dimensions (mm)	Model number	Length	Bundle	Sheath	Range (mm)
-----------------	--------------	--------	--------	--------	------------

MBNW2.3W-1

MBNW2.3W-1	500	ϕ 2.3	W	
------------	-----	------------	---	--

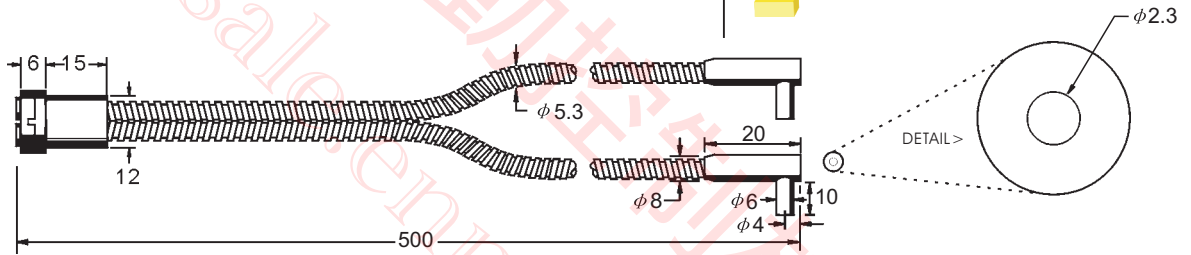

Dimensions (mm)	Model number	Length	Bundle	Sheath	Range (mm)
-----------------	--------------	--------	--------	--------	------------

MBNW2.3W-2

MBNW2.3W-2	500	ϕ 2.3	W	
------------	-----	------------	---	--

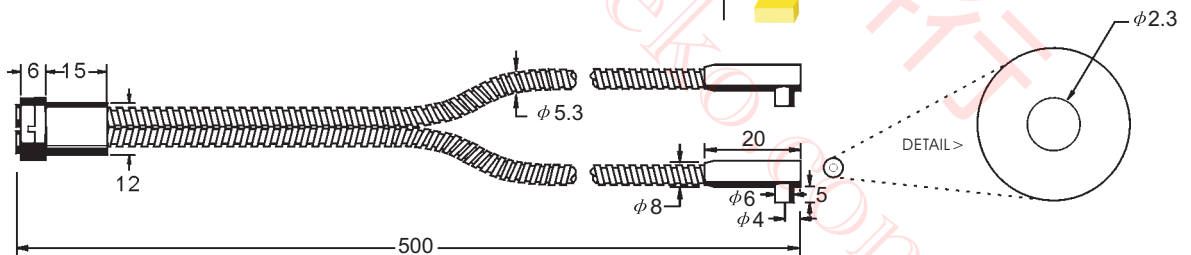

Dimensions (mm)	Model number	Length	Bundle	Sheath	Range (mm)
-----------------	--------------	--------	--------	--------	------------

MBNW1.6N

MBNW1.6N	500	ϕ 1.6	N	
----------	-----	------------	---	--

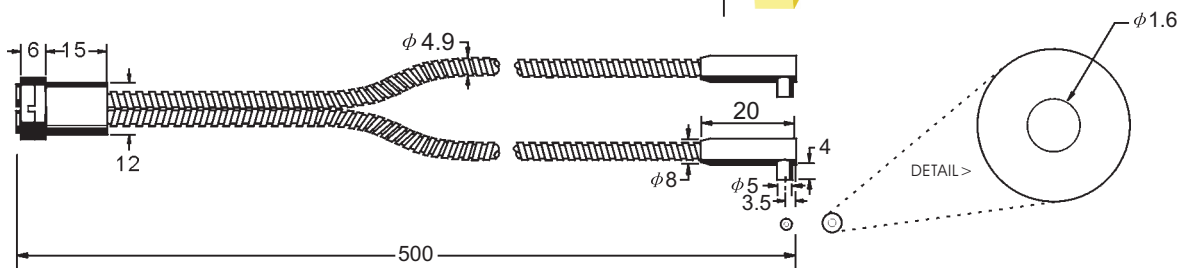

Glass Fibers

Opposed Mode

Individual Cables



Dimensions (mm)	Model number	Length	Bundle	Sheath	Range (mm)
-----------------	--------------	--------	--------	--------	------------

MBNW1.1M

MBNW1.1M	500	ϕ 1.1	M	
----------	-----	------------	---	--

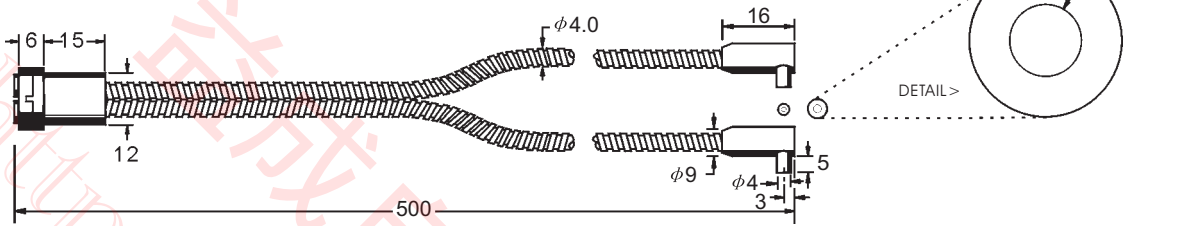

Dimensions (mm)	Model number	Length	Bundle	Sheath	Range (mm)
-----------------	--------------	--------	--------	--------	------------



Dimensions (mm)	Model number	Length	Bundle	Sheath	Range (mm)
-----------------	--------------	--------	--------	--------	------------



Dimensions (mm)	Model number	Length	Bundle	Sheath	Range (mm)
-----------------	--------------	--------	--------	--------	------------



Glass Fibers

Opposed Mode Individual Cables



Dimensions (mm)	Model number	Length	Bundle	Sheath	Range (mm)
-----------------	--------------	--------	--------	--------	------------

EBNW0.8P

EBNW0.8C	500	φ 0.8	PVC	
----------	-----	-------	-----	--

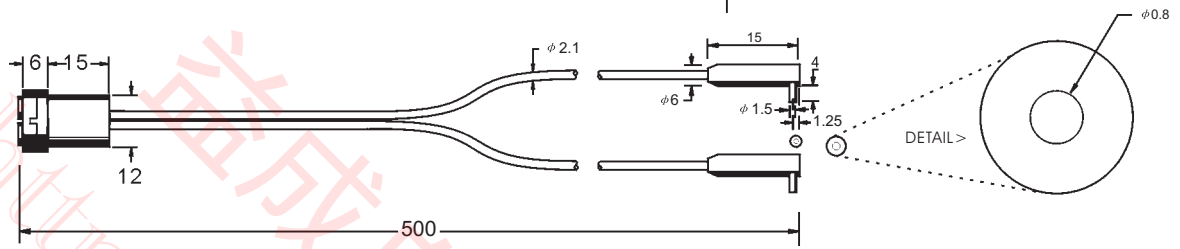
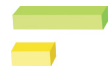

Dimensions (mm)	Model number	Length	Bundle	Sheath	Range (mm)
-----------------	--------------	--------	--------	--------	------------

--	--	--	--	--	--



Dimensions (mm)	Model number	Length	Bundle	Sheath	Range (mm)
-----------------	--------------	--------	--------	--------	------------

--	--	--	--	--	--



Dimensions (mm)	Model number	Length	Bundle	Sheath	Range (mm)
-----------------	--------------	--------	--------	--------	------------

--	--	--	--	--	--

