

■ 特性

- 天得積層式警示燈可裝設於各種機械,以燈光及警鳴聲警示各種突發狀況,可依客戶不同的需求訂製適用的型式及規格。
- 內含彈簧緩衝及抗震設計,可大幅降低燈泡因機台劇烈的震動而損壞的機率。
- 接線自由性高,燈泡的閃滅或常亮及蜂鳴器的鳴聲為間歇或長鳴皆可自由配線改變。
- 鎢絲燈泡及LED燈泡燈座同為BA15S可自由互換。
- 含蜂鳴器的機種,其蜂鳴聲音量約為80dB/1m。
- 固定方式有盤式及桿式,並且有多種腳座可提供選擇。

■ 型號說明

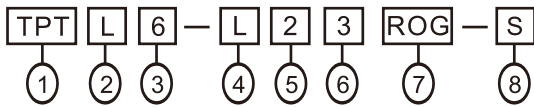

項次	代號	說明
1.固定方式	TPT	桿式
	TPW	盤式
	TPF	可折式(圓形鐵盤)
	TPFQ	可折式(方形鐵盤)
	TPA	側掛式
	TPS	桿盤式
2.功能	L	標準型
	F	閃光型
	S	閃光蜂鳴型
	B	蜂鳴型
3.外徑大小	4	∅40mm (無TPF、TPFQ)
	5	∅50mm
	6	∅60mm
	7	∅70mm
4.燈泡總類	空白	鎢絲燈泡
	L	LED
5.使用電壓	1	110VAC
	2	220VAC
	7	24VAC/DC
	9	12VAC/DC
6.燈數	1~5	1~5
7.燈殼顏色	R	紅
	O	橙
	G	綠
	B	藍
	W	白
8.鋁管長(外露)	空白	標準長, TPT:288mm, TPF:43mm
	S	特殊長, TPT:138mm 特殊長, TPF:193mm

● 標準電線長度0.5米

■ 燈泡及蜂鳴器額定電流(僅供參考)

鎢絲燈泡		LED 燈泡	
S15-I49(12VAC/DC)	0.5A	S15-L59(12VDC)	0.08A
S15-I47(24VAC/DC)	0.25A	S15-L59(12VAC)	0.15A
S15-I41(110VAC)	0.05A	S15-L57(24VDC)	0.05A
S15-I42(220VAC)	0.03A	S15-L57(24VAC)	0.07A
S15-I59(12VAC/DC)	0.7A	S15-L51(110VAC)	0.02A
S15-I57(24VAC/DC)	0.35A	S15-L52(220VAC)	0.02A
S15-I51(110VAC)	0.06A		
S15-I52(220VAC)	0.03A		
S15-I69(12VAC/DC)	0.8A		
S15-I67(24VAC/DC)	0.4A		
S15-I61(110VAC)	0.08A		
S15-I62(220VAC)	0.04A		

蜂鳴器	
12VAC/DC	0.08A
24VAC/DC	0.02A
110VAC	0.01A
220VAC	0.01A

■ 燈泡型號說明

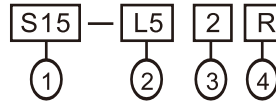

項次	代號	說明
1.燈座型式	S15	BA15S燈泡
2.適用燈殼外徑	I4	∅40mm用, 5W鎢絲燈泡
	I5	∅50mm用, 10W鎢絲燈泡
	I6	∅60mm/∅70mm用, 10W鎢絲燈泡
	L5	LED燈泡 (全系列)
3.電壓	1	110VAC
	2	220VAC
	7	24VAC/DC
	9	12VAC/DC
4.燈泡顏色	空白	鎢絲燈泡
	R	紅
	O	橙
	G	綠
	B	藍
	W	白

■ 燈泡外觀尺寸

鎢絲燈泡
S15-I□□

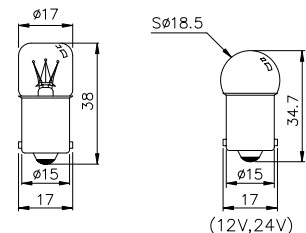

LED燈泡
S15-L5□□

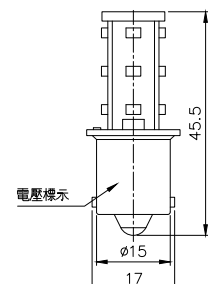

■ 固定孔尺寸

● 盤式

TPW □4/TPW □5

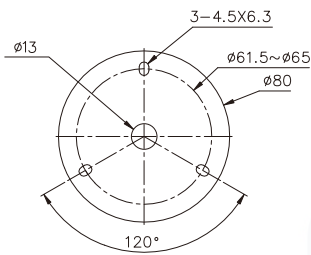

TPW □6

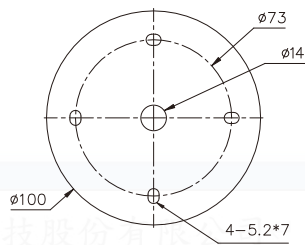

TPW □7

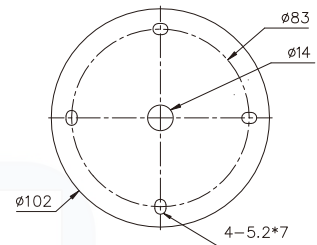
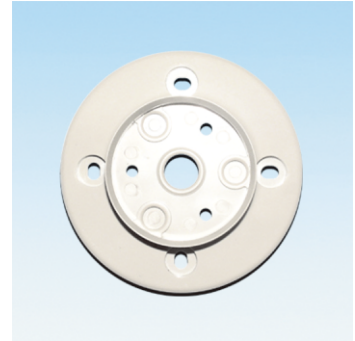

■ 固定孔尺寸

● 桿式腳架

使用於TPTL4

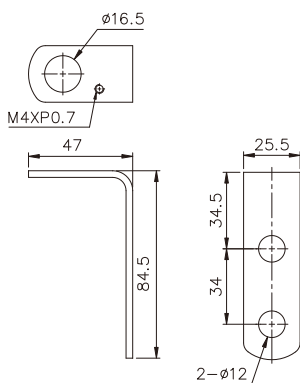

使用於TPT □6/TPT □7

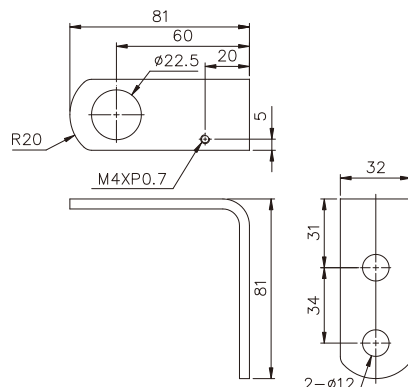

使用於TPTF4/TPTS4/TPTB4
TPT □5

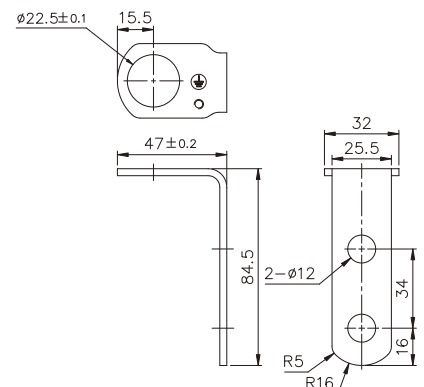

■ 固定孔尺寸

- 桿式腳座 (選購件)

TPTL-S
使用於TPSL4

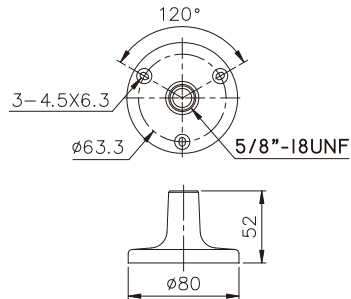

TPTL6-S
使用於TPSS4/TPSF4/TPSB4
TPS□5/TPS□6/TPS□7

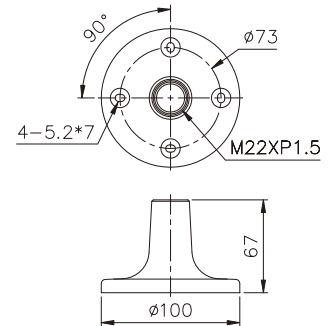

■ 固定孔尺寸

- 側式腳座 (選購件)

TPTL6-A
使用於TPA□4
TPA□5/TPA□6/TPA□7

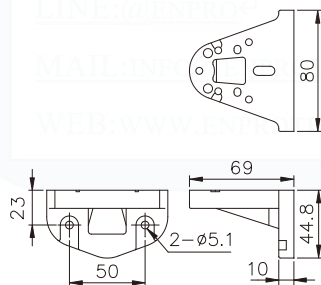

- 可折式腳座 (選購件)

TPTL6-F (新型式專利, 圓形塑膠盤)
使用於TPFS4/TPFF4/TPFB4
TPF□5/TPF□6/TPF□7

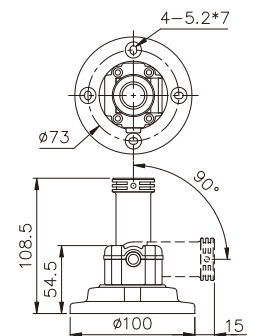

TPTL5-F (新型式專利)
使用於TPFS4/TPFF4/TPFB4
TPF□5/TPF□6/TPF□7

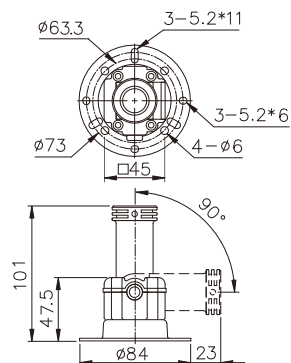

TPTL5-FS (新型式專利)
使用於TPFS4/TPFF4/TPFB4
TPF□5/TPF□6/TPF□7

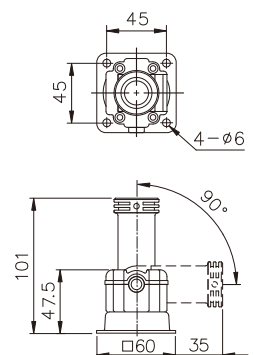



外觀和尺寸

TPTL4

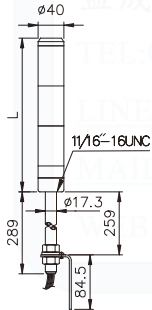

● TPTL4:

燈數	L
1	114
2	176
3	238
4	300
5	362

TPTF4/TPTS4/TPTB4

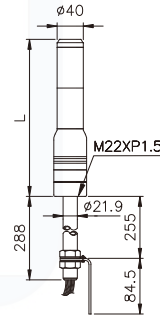

● TPTF4/TPTS4
TPTB4:

燈數	L
1	177
2	239
3	301
4	363
5	425

TPWL4

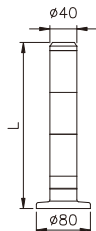

● TPWL4:

燈數	L
1	122
2	184
3	246
4	308
5	370

TPWF4/TPWS4/TPWB4

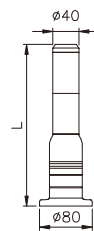

● TPWF4/TPWS4
TPWB4:

燈數	L
1	183
2	245
3	307
4	369
5	431

■外觀和尺寸

TPSL4

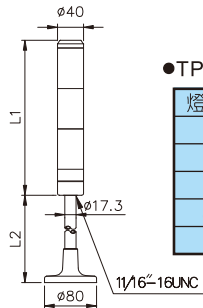

●TPSL4:

燈數	L1	L2
1	114	短133
2	176	長298
3	238	
4	300	
5	362	

TPSF4/TPSS4/TPSB4

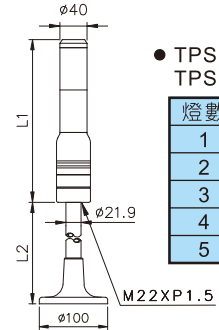

●TPSF4/TPSS4
TPSB4:

燈數	L1	L2
1	177	短161
2	239	長322
3	301	
4	363	
5	425	

TPFF4/TPFS4/TPFB4

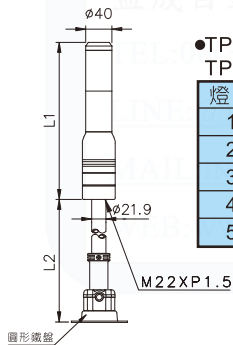

●TPFF4/TPFS4
TPFB4:

燈數	L1	L2
1	177	短146
2	239	長296
3	301	
4	363	
5	425	

TPFQF4/TPFQS4/TPFQB4

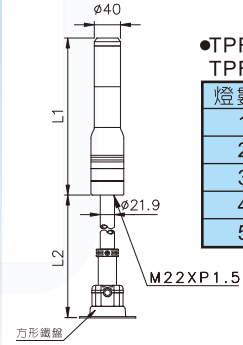

●TPFQF4/TPFQS4
TPFQB4:

燈數	L1	L2
1	177	短146
2	239	長296
3	301	
4	363	
5	425	

TPAL4

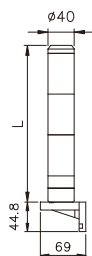

●TPAL4:

燈數	L
1	114
2	176
3	238
4	300
5	362

TPAF4/TPAS4/TPAB4

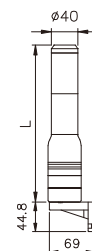

●TPAF4/TPAS4
TPAB4:

燈數	L
1	177
2	239
3	301
4	363
5	425

■ 外觀和尺寸

TPTL5

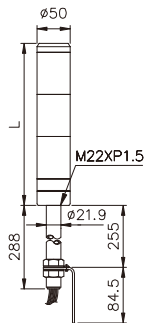

● TPTL5:

燈數	L
1	118
2	182
3	246
4	310
5	374

TPTF5/TPTS5/TPTB5

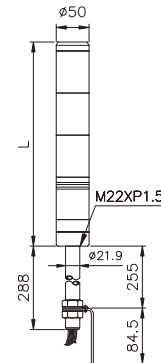

● TPTF5/TPTS5
TPTB5:

燈數	L
1	182
2	246
3	310
4	374
5	438

TPWL5

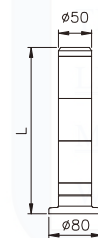

● TPWL5:

燈數	L
1	124
2	188
3	252
4	316
5	380

TPWF5/TPWS5/TPWB5

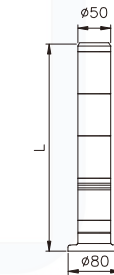

● TPWF5/TPWS5
TPWB5:

燈數	L
1	188
2	252
3	316
4	380
5	444

TPSL5

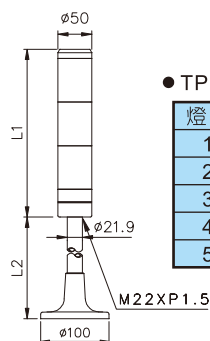

● TPSL5:

燈數	L1	L2
1	118	短161
2	182	長322
3	246	
4	310	
5	374	

TPSF5/TPSS5/TPSB5

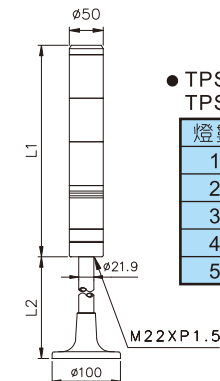

● TPSF5/TPSS5
TPSB5:

燈數	L1	L2
1	182	短161
2	246	長322
3	310	
4	374	
5	438	

■ 外觀和尺寸

TPFL5

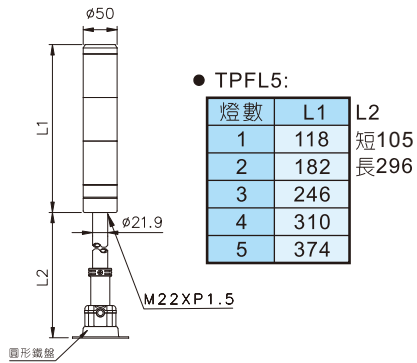

TPFQL5

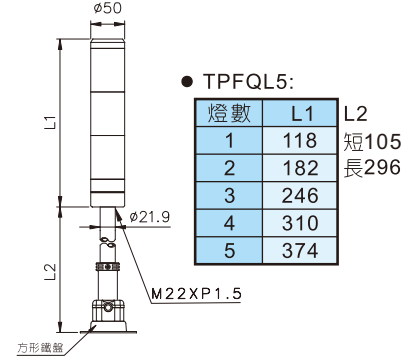

TPFF5/TPFS5/TPFB5

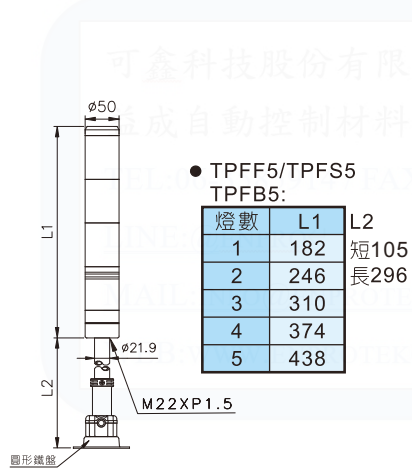

TPFQF5/TPFQS5/TPFQB5

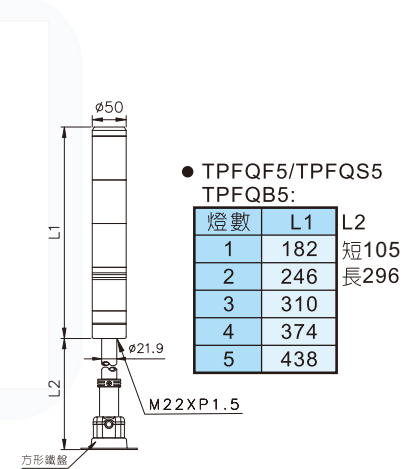

TPAL5

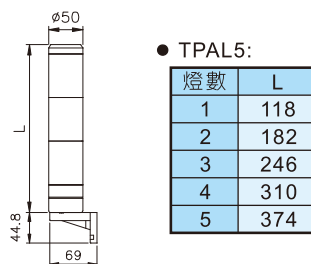

TPAF5/TPAS5/TPAB5

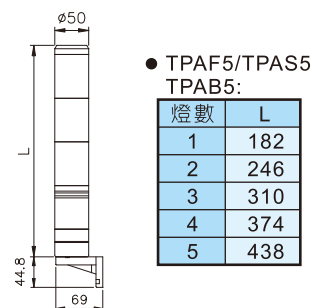

■ 外觀和尺寸

TPTL6

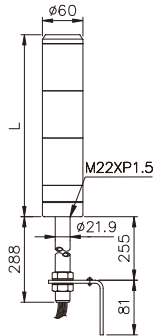

● TPTL6:

燈數	L
1	130
2	200
3	270
4	340
5	410

TPTF6/TPTS6/TPTB6

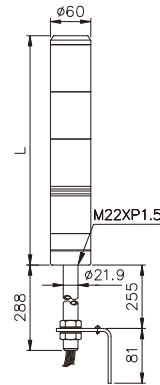

● TPTF6/TPTS6
TPTB6:

燈數	L
1	200
2	270
3	340
4	410
5	480

TPWL6

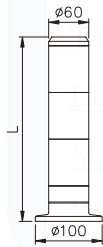

● TPWL6:

燈數	L
1	136
2	206
3	276
4	346
5	416

TPWF6/TPWS6/TPWB6

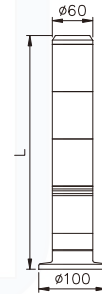

● TPWF6/TPWS6
TPWB6:

燈數	L
1	206
2	276
3	346
4	416
5	486

TPSL6

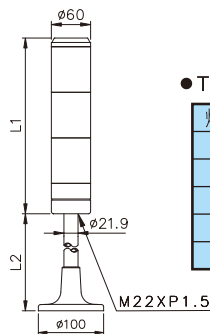

● TPSL6:

燈數	L1	L2
1	130	短161
2	200	長322
3	270	
4	340	
5	410	

TPSF6/TPSS6/TPSB6

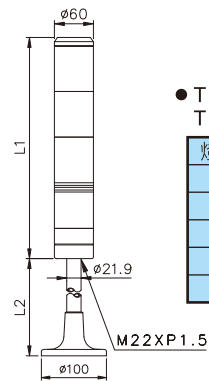

● TPSF6/TPSS6
TPSB6:

燈數	L1	L2
1	200	短161
2	270	長322
3	340	
4	410	
5	480	

■ 外觀和尺寸

TPFL6

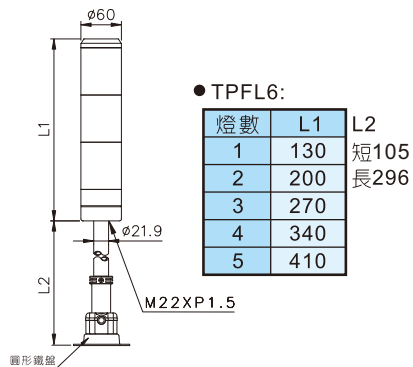

TPFQL6

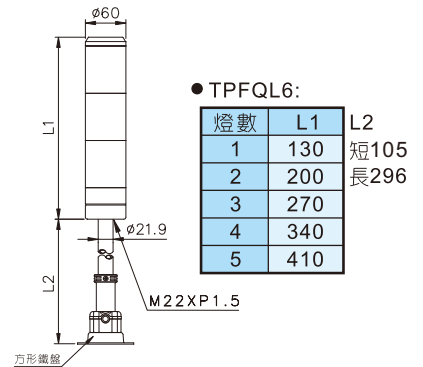

TPFF6/TPFS6/TPFB6

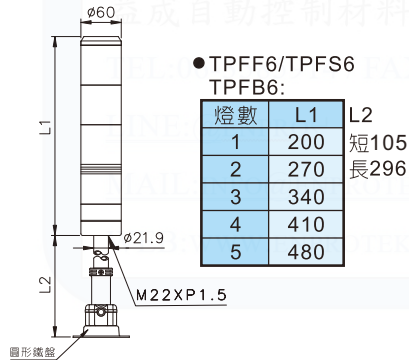

TPFQF6/TPFQS6/TPFQB6

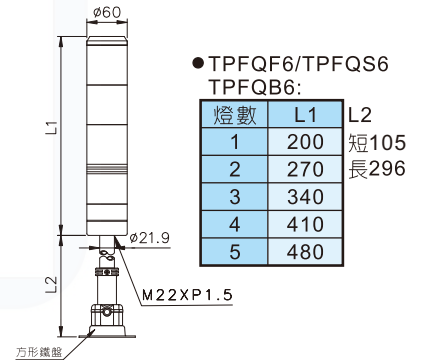

TPAL6

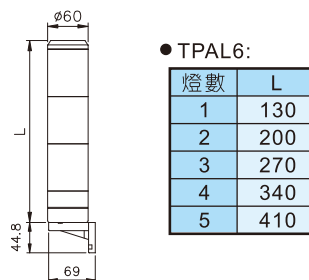

TPAF6/TPAS6/TPAB6

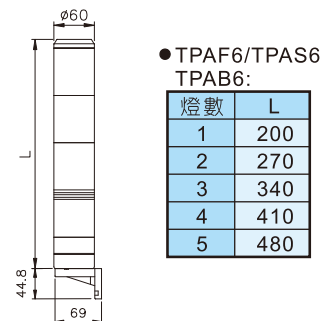

■ 外觀和尺寸

TPTL7

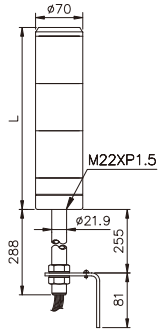

● TPTL7:

燈數	L
1	130
2	200
3	270
4	340
5	410

TPTF7/TPTS7/TPTB7

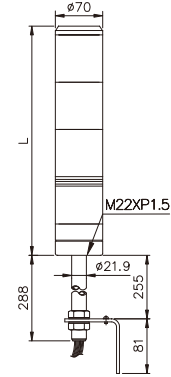

● TPTF7/TPTS7
TPTB7:

燈數	L
1	200
2	270
3	340
4	410
5	480

TPWL7

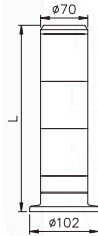

● TPWL7:

燈數	L
1	136
2	206
3	276
4	346
5	416

TPWF7/TPWS7/TPWB7



● TPWF7/TPWS7
TPWB7:

燈數	L
1	206
2	276
3	346
4	416
5	486

TPSL7

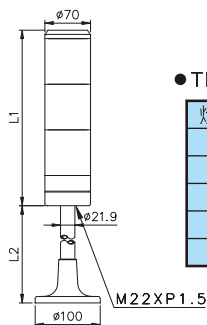

● TPSL7:

燈數	L1	L2
1	130	短161
2	200	長322
3	270	
4	340	
5	410	

TPSF7/TPSS7/TPSB

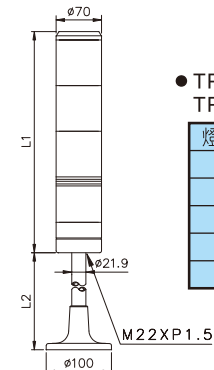

● TPSF7/TPSS7
TPSB7:

燈數	L1	L2
1	200	短161
2	270	長322
3	340	
4	410	
5	480	

■外觀和尺寸

TPFL7

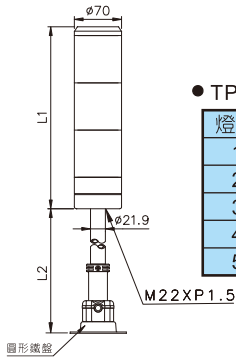

● TPFL7:

燈數	L1	L2
1	130	短105
2	200	長296
3	270	
4	340	
5	410	

TPFQL7

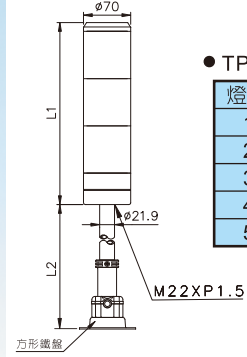

● TPFQL7:

燈數	L1	L2
1	130	短105
2	200	長296
3	270	
4	340	
5	410	

TPFF7/TPFS7/TPFB7

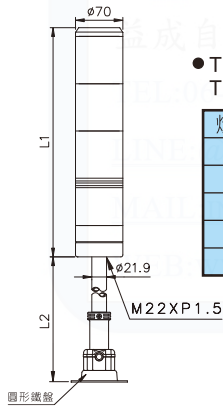

● TPFF7/TPFS7
TPFB7:

燈數	L1	L2
1	200	短105
2	270	長296
3	340	
4	410	
5	480	

TPFQF7/TPFQS7/TPFQB7

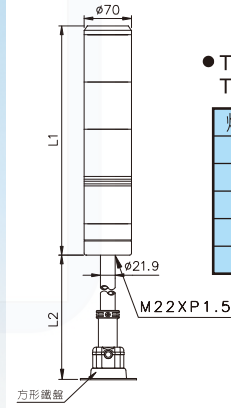

● TPFQF7/TPFQS7
TPFQB7:

燈數	L1	L2
1	200	短105
2	270	長296
3	340	
4	410	
5	480	

TPAL7

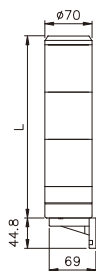

● TPAL7:

燈數	L
1	130
2	200
3	270
4	340
5	410

TPAF7/TPAS7/TPAB7



● TPAF7/TPAS7
TPAB7:

燈數	L
1	200
2	270
3	340
4	410
5	480